

9 ^ YRcRI VXZ \_Rj 9 XcZIf ]ef cRj I VXZ \_Rj A\_deZf eV\$9 I 9 I A%

Gc` TWUZ\_Xd` WeYV- de 9 \_\_f Rj I VXZ \_Rj ; ` \_WcV\_TV` \_  
 ; ` ^ a]VeWUI VdVrcTY` \_ ERef cRj I Vd f cTVdD R\_RXV^ V\_e

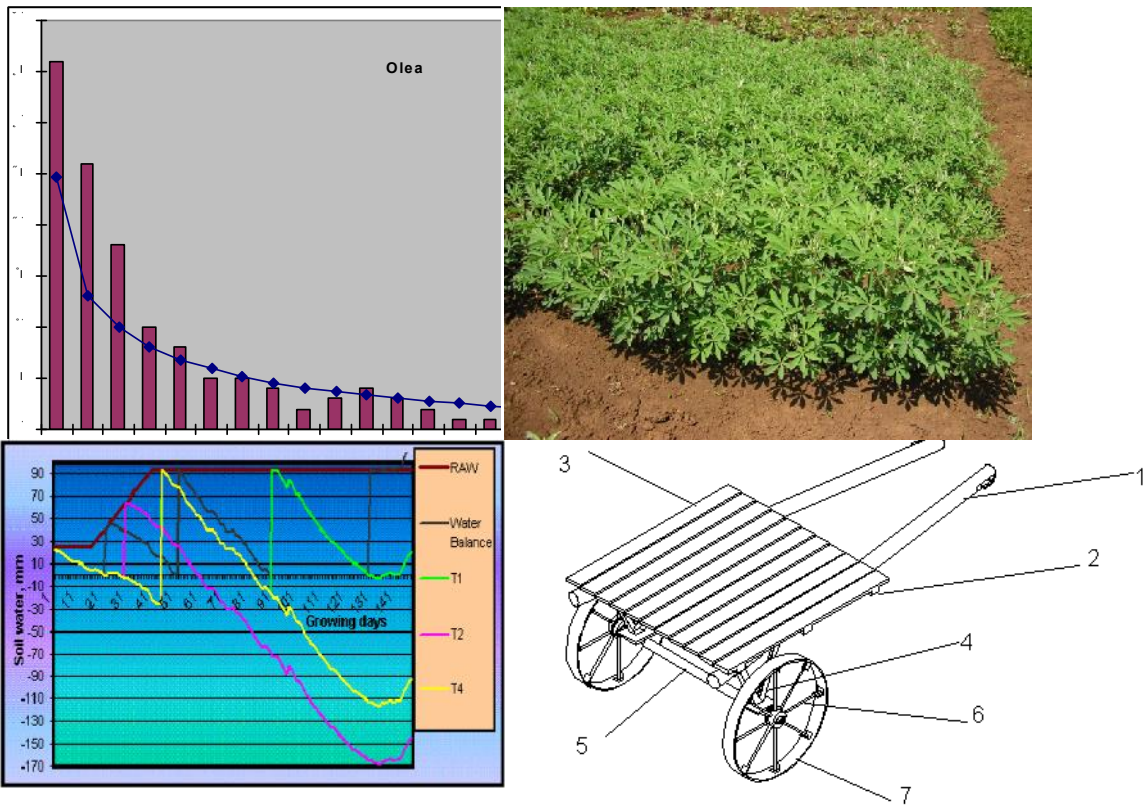

- 0) - 3 9 f Xf de( . , , 2  
 9 I 9 I A : RYZ < Rc( =eYZaR

9 ^ YRcRI Vxz\_Rj 9 XcZif jef cRj I Vxz\_Rj A\_deZf eV\$9 I 9 I A%

Gc` TWUZ\_Xd` WeYV- de 9 \_\_f Rj I Vxz\_Rj ; ` \_WcV\_TV` \_  
; ` ^ a]VeUI VdVrcTY` \_ ERef cRj I Vd f cTVdD R\_RXV^ V\_e

- 0)- 3 9 f Xf de. , , 2(9 I 9 I A : RYZ < Rc =eYZ aR

=UÆ cd

OZYV\_Vh ? \*jVjRddV

=\_j Vh 9 UX

PVh f Uf 9 j RjVh

9 ScYR^ 9 SZf

: VjRj KdVXR\_VY

Correct citation: Yihenew G. Selassie, Enyew Adgo, Zewudu Ayalew, Abrham Abiyu and Belay Tseganeh (eds). Proceedings of the 1<sup>st</sup> Annual Regional Conference on Completed Research Activities on Natural Resources Management. 14-17 August 2006, ARARI, Bahir Dar, Ethiopia

## >` ch RcU

Following regionalization and political empowerment of regional states in 1991, three research centers (Adet, Debre Berhan or the then Sheno Research Centre and Sirinka) were transferred to Amhara National Regional State in 1995. By then, the centers were at a very low status and capacitating the centers to bring about agricultural research that can support the overall of agricultural development endeavors in the region was the main task. In about five years time after 1995, the research centers assumed relative strength and embarked on planning agricultural research that primarily reflect the region's interest. Eventually, some technology multiplication centers joined the research system and new centers/sub-centers were also opened in different agroecologies of the region. The scope of agricultural research in the region got impetus and this heralded the beginning of problem oriented and region specific agricultural research in almost all disciplines. This was verified by strong annual research program review at all levels with the participation of relevant stakeholders, complemented by field evaluation.

It was noticed, however, that the annual research program review forum focused more on evaluation of new research activities and overlooked completed research activities. This was the main reason to initiate annual regional conference to evaluate completed research activities and filter those research findings or technologies that can be transferred to the users and pass decision on those which are not. It is, therefore, hoped that the research findings included in this first proceeding are critically evaluated and is believed that the proceeding will serve as a useful means of communication with stakeholders. Moreover, the forum will serve as part of monitoring and evaluation system of research activities and due consideration will be given for its continuity.

Alemayehu Assefa (PhD)  
Deputy Director General  
Amhara Regional Agricultural Research Institute  
Bahir Dar-Ethiopia

## KRSJV W`\_eV\_ed

	GRXV
<b>;`_eV_ed</b>	
<b>Soil Fertility Management</b>	1
Adaptability of Introduced Green Manuring Plant Species for Soil Fertility Replenishment	1
Green Manure: an Option for Replenishing Soil Fertility and its Compatibility with the Farming System of Gojam.	10
Soil Test Based N and P Fertilizer Rate Recommendations of Maize for West Amhara	16
<b>Soil and Water Conservation</b>	
Quantifying the Impacts of Livestock Trampling on Runoff, Soil Loss and Crop Yield under Traditional Teff Cultivation System	37
	42
<b>Agricultural Water Management</b>	
Inventory and Characterization of Potentials and Management of Wetlands in North Shewa	42
Crop Water Requirement of Selected Crops and Frequency of Irrigation on Bread Wheat	49
<b>Agro meteorology and Remote Sensing</b>	61
Agro Metrological and Cropping Pattern Analysis in North-Eastern Part of Amhara Region (A Case of North Shewa)	61
<b>Forestry/Agroforestry</b>	72
Study on Indigenous Tree and Shrub Species of Churches, and Monasteries of Wag-Lasta District	72
Evaluation of Different Water Harvesting Techniques in Improving the Survival Rate of Tree Seedlings in Simada Woreda	85
<b>Agricultural Mechanization</b>	97
Modification and evaluation of SG-2000 multi- crop thresher	97
Performance Evaluation of Donkey Drawn Carts	112
Testing of Out-Door Storage Structures on Maize	119

# Journal of Agricultural Research

## 9 URacRSZj `WA ec` Uf TU? cW\_ DR f cZ\_XGR\_e Ja VIZd Wc J` Z>VceZj I VaJV\_ZY^ V\_e

Tesfaye Feyisa<sup>1</sup>, Tadele Amare<sup>1</sup>, Yihenew G.Silassie<sup>1</sup>, and Enyew Adgo<sup>2</sup>  
<sup>1</sup>Adet Agricultural Research Center, P.O.Box 08, Bahir Dar

### 9 SdecRle

Adaptability of 16 introduced green manuring plant species was seen during 2004-2005 cropping seasons at Adet, Ayehu and Injibara with the objective of selecting the best adaptable and high biomass producing plant species. The plants were evaluated for their biomass, ground cover, weed suppressing ability and presence or absence of disease and insect damage. The experiment was laid down in a randomized complete block design with three replications. Based on the parameters considered,

and produced 26, 25, 21, 22 and 20 tons of fresh biomass ha<sup>-1</sup> and 5.5, 6.0, 5.0, 4.8, and 4.0 tons of dry leave and twigs biomass ha<sup>-1</sup> respectively, and also had high ground cover, high weed suppressing ability, and had no disease and insect problem. Therefore, the aforementioned species were found to be the best adaptable green manuring plants followed by

also produced high biomass, had good ground cover and suppressed weeds very well, but pod boring insect was observed on its pod and hence it is not selected as green manuring plant until further investigation will be carried out on the entomological part. followed by species was fast in flowering of all the tested plants and can even benefit the associate crop, but it was not selected for green manuring due to its poor biomass production. species was also not selected due to its low plant biomass and high infestation by pod boring insect. The rest plant species were poor in establishment across all trial sites and hence, other ecologies that best fit them should be identified.

**BYj h` cUd** adaptability, biomass, green manuring, ground cover, soil fertility

### A ec` Uf TeZ\_

Depletion of soil fertility, along with the concomitant problems of weeds, insects and diseases, is a major biophysical cause of low per capita food production in Africa (Snchez et al., 1997). Over decades, small scale farmers have removed large quantities of nutrients from their soils without using sufficient quantities of manure or fertilizers to replenish the soil. This has resulted in a very high average annual depletion rate: 22 kg of nitrogen (N), 2.5 kg of phosphorus (P), and 15 kg of potassium (K) per hectare from cultivated lands over the last 30 years in 37 African countries with an annual loss equivalent to 4 billion dollars in fertilizer (Drechsel and Gyiele, 1999). The potential of genetically improved crops can't be realized when soils are depleted of plant nutrients.

The traditional way to overcome nutrient depletion is the use of mineral fertilizers. However, fertilizer in Africa costs two to six times as much as those in Europe, North America or Asia due to various socio economic constraints (Sanchez, 2002; David and Swinkel, 1994 and Gezahegn and Tekalign, 1995). Therefore, the integration of organic fertilizers such as green manure in the cropping system is being regarded as alternative to

mineral fertilizers in most tropical soils. It is mainly because, green manuring plant species can provide essential nutrients such as N, P, K and trace elements and improve soil structure through intensive root penetration and organic matter accumulation. Some plant species can also access non available P through root exudates or association with mycorrhiza (Godbold, 1999 and Rao et al., 1999).

A soil fertility replenishment approach has been developed during the last 1.5 decades by researchers from International Center for Research in Agroforestry and national and International partners working with farmers using resource naturally available in Africa. The practice consists of three components that can be used in combination or separately: i) nitrogen fixing leguminous tree fallows, ii) indigenous rock phosphate in phosphorus deficient soils, and iii) biomass transfer of leaves of nutrient accumulating shrubs (Sanchez and Jama, 2002).

Sanchez (2002) reported that 100 to 200 kg N ha<sup>-1</sup> was accumulated from interplanting leguminous trees of the genera *Gliricidia*, *Leucaena*, and *Acacia* into a young maize crop and allowed to grow as fallow during dry season in sub humid tropical regions of East and South Africa. The same author added that nitrogen rich leaves, pods and green branches of the tree fallows were hoed into the soil before planting maize at the start of the subsequent rainy season and releases nitrogen and other nutrients to the soil thereby increased maize yield 2 to 4 fold over the control.

Nziguheba (2002) also reported that tithonia, lantana and croton recorded larger amount of resin P (112 %, 76 %, and 56 %, respectively) than values predicted by their P content and TSP response curve. They further stated that, the P and N taken up by plants can be turned to the soil in the plant available forms by biomass application. Eastwood and Sartain (1990) also reported that organic anions released from decomposing residues can compete with P for adsorption site making the P more available to crops.

Degradation of soil organic matter (OM) under continuous cropping is a major reason for decreasing soil fertility. Decomposition of OM is the sequence of microbial processes that is enhanced by increasing temperature, aeration, and optimal moisture content. Such conditions prevail particularly under intensive cropping system. Therefore, the most effective means of arranging natural supply of N and organic matter to a soil is the cultivation of suitable legumes and their insitu incorporation at appropriate stage of growth (Tiwari et al., 2000).

Nziguheba (2002) reported that despite their P and N concentration, organic residues (green manures) may have additional benefits in increasing P and N availability as compared to chemical fertilizers due to their positive effect on soil physico chemical properties. In addition, green manuring plants can also be used for different purposes such as human food, animal feed, weed suppression and crop pest control.

Hence, in countries like Ethiopia, the use of green manure alone or in combination with chemical fertilizers seems the best alternative to improve soil fertility and sustain production and productivity. However, the use of plant biomass for nutrient replenishment and other purposes require the identification of species with an ability to increase nutrient availability to crops. The objective of this study was, therefore, to select the best adaptable and high biomass producing green manuring herbaceous and shrub legume and non legume species.

**D R E V E R U D V E Y U**

The adaptation trial of 16 introduced green manuring plant species was carried out at Injibara, Adet and Ayehu research stations representing high and mid altitudes. The species were selected for good adaptation, high biomass and efficiency in suppressing weeds. The green manuring plants for which adaptability was tested were

and species.

Seeds of most green manuring plants that need cold or hot water treatment before sowing were treated to enhance germination whereas seeds of some green manuring plants that don't need any treatment were sown directly. The summary is indicated in Table 1.

Table1: Treatments of seeds of green manuring plant species before planting

Species name	Treatment	Time taken for soaking (hours)
	Soaked in hot water	24
	”	24
	”	24
	”	12
	Soaked in warm water	6
	Soaked in cold water	48
	”	12
	”	12
	”	6
	”	3
	No treatment	-
	”	-
	”	-
	”	-
	”	-
	”	-
species	”	-

Fresh and dry leaf and twigs biomass was determined for the promising plant species. The biomass was determined by taking samples from one meter square, weighed immediately, sun dried and repeatedly weighed until constant weight was achieved to determine dry biomass for other than and . Whereas, for and , the biomass was determined based on the number of trees per hectare (i.e. 10,000 trees per ha). Plant height was also measured using a meter scale for the promising green manuring plant species. Three plants were selected from each plot to measure the height and the average of the three was taken as the plant height of the respective plant species.

## I Vif Jed R U < ZIf dZ \_

The results of the experiment indicated that various green manuring plant species included in the experiment had differences in fresh biomass yield, dry biomass yield and plant height (Table 2).

Table 2: Fresh and dry biomass yields of leaves and soft twigs and plant height of green manuring plants species.

Species Name	Mean fresh biomass yield ( ton ha <sup>-1</sup> )	Mean dry biomass yield ( ton ha <sup>-1</sup> )	Average plant height ( meter)	Remark
	20.0	4.0	2.28	
	11.0	2.0	2.62	
	26.0	5.5	4.15	
	25.0	6.0	3.97	
	21.0	5.0	3.28	
	8.0	2.4	0.79	
	8.0	2.3	1.78	creeping
	22.0	4.8	2.20	creeping
species	7.0	1.3	1.90	
	5.0	1.0	1.72	

### *Crotalaria grahamiana*

It germinated very well, had very good establishment and biomass yield as well as ground cover (Figure 1a) both at Adet and Ayehu. However, a few seedlings performed unsatisfactorily at Injibara. It suppressed weeds due to its high biomass (Table 2) and dense plant population. It has no insect and disease problem and reached 50% flowering six months after sowing.



Figure1: Performance of *Crotalaria grahamiana* at vegetative (a) and flowering stages (b) and its leaf foliage (c)

During the second year, the plant started the second round flowering and attained 2.28 m average height 3 months after first seed harvest (Figure 1b). Compared to the first year, both biomass yield and flower initiation were better during the second year. The plant has a complete flowering habit and hence had uniform maturity. It has effective and reasonable number of nodules at 50% flowering. The leaf foliage covered the surface of the soil and could help to improve the fertility of the soil (Figure 1c).

In general, since it established well, produced high leaf biomass, was free from insect and disease, and is not eaten by animals, the plant is found to be suitable for green manuring particularly for improved fallow and biomass transfer. As very recently observed, *Crotalaria grahamiana* established and flowered at Injibara after one year and nine



months. Hence, if proper management is made, it may be the best solution to improve soil fertility in the high lands too.

### ***Crotalaria paulina***

Similar to *Crotalaria juncea*, it established well and had deep green and soft (easily decomposable) leaves and stems at vegetative stage (Figure 2a) both at Adet and Ayehu, whereas none was established at Injibara. It has also a good plant biomass at Adet & Ayehu (Table 2).

Its leaves were damaged by insects during the seedling stage but, it was not a problem at the later stage. It reached 50% flowering stage 8 months after sowing. The plant has indeterminate flowering habit and hence seed maturity was not uniform. Pod boring insect was observed on the pods. The number of pods per plant is high following *Crotalaria juncea* and followed by *Crotalaria retusa* species among the *Crotalaria* plants. During the second year, the plants reached 50% flowering and attained 2.62 m average plant height 3 months after the first seed harvest (Figure 2b). Since *Crotalaria paulina* grows erect and has long and soft (succulent) stem, some stems fail to carry the pod bearing branches and were easily broken. Since it has vigorous growth and high plant biomass, there was no problem of weed. There was also good addition of nutrient from leaf foliage (Figure 2c).



Figure 2: Performance of *Crotalaria paulina* at vegetative (a) and 50% flowering stages (b) and its Leaf foliage (c)

In general, the plant is suitable for green manuring at Adet and Ayehu due to the additive advantages it has to the soil. However, since there is a pod boring insect, further investigation on the entomological aspect is essential before taking the plant to farmers' field.

### ***Crotalaria juncea***

It is an annual green manuring plant and fast in germination both at Adet and Ayehu. However, no establishment was observed at Injibara. The biomass produced was poor: 5 tons fresh biomass  $\text{ha}^{-1}$  and  $< 1$  ton dry biomass  $\text{ha}^{-1}$ . It attained 50% flowering and average plant height of 1.46 m within 2 and half months after establishment and matures after 3 months. Since the biomass and ground cover of the plant was poor and the plant grows erect and sparsely, there was high weed infestation.

It has no insect and disease pest problem. It is early maturing and can even benefit the associate crop if incorporated at 50% flowering particularly for row planted crops like maize and sorghum. It can also be sown on tef land ahead of planting time and incorporated before sowing. It has small sized and very small amount of nodules per

plant. This might be due to poor performance of the associate rhizobia under such conditions. For the above reasons, though it was early maturing and free from disease, it was not selected as green manuring plant at Adet, Ayehu, Injibara, and cannot be recommended for areas with similar agro ecologies. Therefore, it should be evaluated under lower altitudes than the present experimental sites.

### ***Canavalia ensiformis***

It is a biennial and broad leaved plant with good establishment. Even though its leaves were damaged by insects at seedling stage, it has moderate plant biomass yield (Table 2) and ground cover. It also suppressed weeds very well due to its interlocked canopies (Figure 3a).

It started flowering seven months after planting during the first year and reached 50% flowering at 7.5 months and produced large sized seeds from large sized pods. The leaf fall can improve soil fertility for there is reasonable biomass addition to the soil surface (Figure 3b). The plant is suitable for intercropping with row planted crops such as maize, fruit trees etc or can be grown on fallow fields. No nodule formation was observed on roots of 5 representative plants taken from a plot during nodule counting. This may be due to the absence of the symbiont bacteria in the soil. Hence, there may be a need to introduce the symbiont bacteria or search for other ecologies where the rhizobia may be found.



(a) Leaf foliage of covering the soil (b)

### ***Tithonia diversifolia***

It is a perennial shrub, succulent, vigorous in growth and has many branches. The leaves are broad and deep green in color. It has very good establishment, high plant biomass yield (Table 2) and good ground cover. Better than all the plant species included in the trial, it suppressed weed very well due to its dense canopy cover (Figure 4a).

It stayed vegetative during the first year both at Adet and Ayehu (Figure 4a). However, only few plants flowered 9 months after planting and small amount of seed was collected at Ayehu. Most plants, in both sites (Adet and Ayehu), started flowering one year and 3 months after planting and reached 50% flowering after 1 year and 4 months and its average plant height was 4.15 m. It has indeterminate flowering nature and there was no uniform seed maturity. The seeds are very light and can shatter easily if not closely attended and collected. Tithonia produced flower from all branches and hence large amount of seed can be produced (Figure 4b). However, due to its tall height (Table 2), it was difficult to collect all the seeds and hence there was a great shattering loss. Therefore, canvas should be laid under the plants during seed collection. There was high additions of biomass from leaves to the soil and can replenish soil fertility (Figure 4c). There was no disease and insect pest

problem. In general, due to its high plant biomass (leaves and twigs) and freedom from disease and insect pests, the plant can be used as green manuring plant particularly for biomass transfer (by planting on farm boundaries and at sides or floor of gullies) but not for intercropping for it can suppress the associate crop by competing for light and other nutrients.

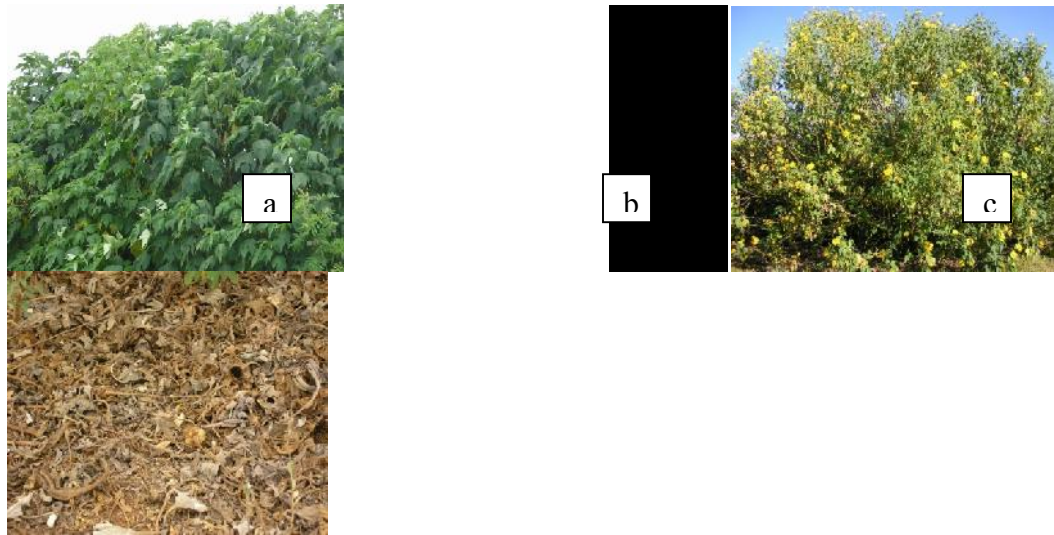

Fig.4: Performance of *Tephrosia candida* at vegetative (a) and flowering stage (b) and leaf foliage (c)

***Tephrosia candida***

has very good establishment and ground cover, high biomass yield (Table 2), and has vigorous stand like that of Tithonia. There was no problem of insects and diseases. It has high weed suppressing ability next to Tithonia.

The plant stayed vegetative during the first year and started flowering during the second year i.e. 1 year and 2 months after establishment and reached 50% flowering a month after starting flowering (Figure 5a) and has attained an average plant height of 3.97 m. The plant can be used as alley crop, as boundary plantation for biomass transfer, intercropped with row planted crops or can be planted on fallow lands to replenish the fertility of the soil. It can also be grown on soil conservation structures as biological measure and can check soil and water loss. The twigs and leaf mass can be incorporated to the nearby field or will be taken to other farm as biomass transfer. Foliage from leaves can improve soil structure and increases organic matter content of the soil.



at flowering stage (a) and Leaf foliage of covering the soil surface (b)

### ***Dolichos lablab***

Lablab is a biennial green manuring crop. It has poorly germinated and the leaves were damaged by insects during establishment. However, two months after establishment, it covered the surface and suppressed weeds.

It had high biomass yield (Table 2) and good canopy cover (Figure 6a). The leaf foliage can improve soil fertility (Figure 6b). It flowers early, next to and sp. It has indeterminate flowering nature and no uniform seed maturity was attained. Lablab best suits for gully reclamation for it is fast to cover the sides and floor of the gully and checks erosion. It can also be grown on fallow lands to replenish the fertility of the soil. In addition, it could be intercropped with row planted crops like maize, sorghum and other perennial fruit crops. It is also a good animal feed which can be a supplementary diet to low protein rations.



Figure 6: Performance of *D. lablab* at vegetative stage (a) and its leaf foliage covering the soil surface (b)

### ***Tephrosia vogelli***

It is similar to except it was earlier in maturity and shorter in plant height (Table 2) and produced large amount of pods per plant. It started flowering during the second year like but only one month earlier. It has however, relatively lower biomass compared to (Table 2).

### ***Mucuna prunensis***

Its establishment was very good and produced moderate amount of biomass (Table 2). However, there was insect damage on the leaves during emergence resulting in stunted growth. Like lablab, it is a creeping plant and needs stake support and continuous pruning for proper management. It can be planted intercropped with maize and other row planted crops and perennial fruit trees to benefit the associate crop as well as the next crop. It can also be grown on fallow lands to replenish the fertility of the soil. It flowers 8 months after establishment. The pods are attached to the stem and covered by leaves and hence, needs care during seed collection. The plant has indeterminate flowering habit.

***Leucunea trichondra, Leucunea diversifolia, Leucunea pallida, Calliandra calothyrsus, Desmodium uncinatum, Glyricida sepium***

These species poorly germinated at Adet and Ayehu and none of them germinated at Injibara. Though germinated at Adet and Ayehu, they were not fit to be used as green manure for they were poorly established and produced poor biomass. The plots were heavily infested by weed. However, they all are good animal feeds and known green manuring plants. Therefore, better ecology that could suit them should be identified.

***Crotalaria daVIDA***

It has poorly established and produced poor biomass (Table 2) compared to other Crotalaria plant species due to low seed rate. However, it could give good biomass under relatively high seed rate and shallow seed depth during sowing. At deep seed depth, since the seed size is very small, it may fail to emerge. It has deep green and soft leaves and twigs which can serve as green manure. There was however, high weed infestation due to sparse plant population. Nevertheless, it is very fast in flowering following . It flowers 2.5 months after establishment and reached 50% flowering at the third month. During nodule counting, it was observed that there was reasonable nodule which was effective and large in number next to

It has large amount of pods per plant and produced large amount of seed. Since it is very fast in maturity, it can benefit the associate crop if incorporated to the soil at 50% flowering. The pods were damaged by pod boring insect. The insect was identified by the entomology section of the Adet ARC as it belongs to the order of Lepidoptera. The insect bores the pod at early stage, grows inside the pod and feeds on the seeds. Therefore, the plant is not selected as green manuring plant until further investigation is made on the entomological part.

***; ` \_Tjf dZ\_ R UI VT ^ ^ V\_URz\_***

For most Ethiopian farmers, who do not use chemical fertilizers or use very small amount (far below the recommended rate) due to high cost, and who do not use organic manures and plant residues for they used them for fuel, thatching, animal feed and construction, green manuring is the best alternative to replenish soil fertility. Therefore, special focus should be given to introduction of green manuring plant species that could fit to different agro ecologies of the country from other countries that have good experience in this regard. Among the introduced green manuring plant species,

were adapted very well at Adet and Ayehu



followed by

The others were not adapted.

Therefore, the following recommendations can be forwarded:

- Well adapted plant species should be evaluated for their nutrient contribution efficiency ;
- Best agro ecology that suits to those species which fail to adapt in ecologies covered in this experiment should be identified
- Efforts toward introduction of green manuring plant species for different agro ecologies should not be limited,
- Further investigation on the pod boring insect damaging and should be made

## **I W&V TVI**

- David, S. and R.A., Swinkel. 1994. Socio economic characteristics of households engaged in agroforestry technology testing in Western Kenya. AFRENA report 78. International Center for Research in Agroforestry, Nairobi.
- Eastwood, G.W. and J.B., Sartain. 1990. Clover residue effectiveness in reducing orthophosphate sorption on ferric hydroxide coated soil. Soil Science Society of America Journal 54: 1345-1350
- Gezehagn Ayele and Tekalign Mamo. 1995. Determinants of demand for fertilizer in a Vertisol cropping system in Ethiopia. Tropical Agriculture (Trinidad) 72: 165-169.
- Godbold, D.L. 1999. The role of mycorrhizas in phosphorus acquisition special issues on phosphorus availability, uptake and cycling in tropical agroforestry. Agroforestry forum 9, 25-27
- Nziguheba, G., Merckx, R. and C.A., Palm. 2002. Contribution of organic residues to soil phosphorus availability in the highlands of Western Kenya. In: Vanlauwe, B., Diels, J., Sanginga, N. and R., Merckx (Eds) Integrated nutrient management in Sub-Saharan Africa 2002. CAB International Publishing. UK pp 133-142.
- Rao, I.M., Friesen, D.K. and W.J., Horst. 1999. Opportunities for germplasm selection to influence phosphorus acquisition from low phosphorus soils. Agroforestry forum 9: 13-17
- Sanchez, P.A., Buresh, R.J. and B., Leakey. 1997. Replenishing soil fertility in Africa. Soil Science Society of America. Special publication No. 51, Madison.
- Sanchez, P.A. 2002. Soil fertility and Hunger in Africa. Science, 295(5562) pp 1-6.
- Sanchez, P.A. and B.A., Jama. 2002. Integrated Plant Nutrient Management in Sub-Saharan Africa: from Concept to Practice. pp 23-45. CABI, Wallingford, UK.
- Tiwari, V.N., Tiwari, K.N. and P.N., Awasthi. 2000. Role of and phosphomicrobe at varying levels of N in sustaining the production and productivity of soil under rice-wheat/chickpea cropping sequence. Journal of Indian Soc. Soil Sci. 48(2): 257-262

? cW\_ D R\_f cV6R\_ F aeZ\_ Wc I VaJV ZYZ XJ` Z > VceZ4j R\_U Zd; ` ^ aReSZ4j  
h ZY eYV>Rc^ Z XJj deV^ ` W ` [R^ \*

Tadele Amare<sup>1</sup>, Yihene G. Selassie<sup>1</sup>, Enyew Adigo<sup>2</sup> and Tesfaye Feyisa<sup>1</sup>

<sup>1</sup> Adet agricultural Research Center, P. box, 08, Bahir Dar,

<sup>2</sup> ARARI, P.O.BOX 527, Bahir Dar

## 9 SdecRle

Soil fertility is one of the major yield limiting factors in Ethiopia. Awareness is very high for chemical fertilizer by the majority of farming society, but its cost and accessibility is challenging. Improving the efficiency of chemical fertilizers and exerting more effort to organic fertilizer is essential to increase productivity of the soil. Green manure is part of organic fertilizers that has immense positive effects upon the soil. Identification where and when to invest on green manure technology is a critical point upon its success. A research on green manure was carried out for two years on the nitisols of Gojam and two systems were identified that green manure could be introduced in the studied area. I. Possibility of growing lupine with residual moistures after barley harvest and using it for green manure. II. Possibility of growing lupine and vetch before tef sowing and using for green manure. For the first experiment, lupine was planted after barley harvested (in September) and under plowed at 50% flowering. Maize var. BH 540 was planted in May-June to evaluate the contribution of the green manure. Very highly significant difference was obtained between treatments. An increase of 890 kg/ha grain yield over usual practice of farmers was obtained using green manure. For the second experiment lupine and vetch were planted for green manuring just at the start of the rainy season and under plowed in the second week of July. After seven days of incorporation, tef was sown and encouraging results were obtained (1404, 1604, 1722 kg/ha from control, lupine and vetch plots respectively). Moreover, the technology is very easy and cheap that farmers can easily adopt it. Therefore mechanism to scale up this research out put both at regional and national level should be devised.

Key words: Farming system, Green manure, Lupine, Organic fertilizer, Soil fertility, Vetch

## A ec` Uf TeZ\_

Agriculture generates the lion's share of gross national income of Ethiopia. Weather condition and soil fertility are the main limiting factors for agricultural production in our country. It also works for other sub-Saharan Africa countries (Makken, F., 1993). Smaling (1993) reported that sustainable agriculture through maintaining and improving the chemical fertility of the soil remains to be a prominent indicator. Chemical fertility of Ethiopian soils has deteriorated due to depletion of nutrients (Smaling, 1993), low rate of chemical fertilizer application (Lakew et al., 2000) and high soil erosion (FAO, 1986).

Some years ago, the farming system of Ethiopia was extensive type and targeted using virgin lands. This type of farming system is non sustainable and no more existent today, as population pressure reached to its climax. The cost of chemical fertilizers also increased alarmingly from time then. For example the cost of DAP was 42 Birr in 1973/74 (FAO, 1986) and increased to 400 birr in 2006 per 100 kg. These all aggravated the negative nutrient budgets of the soil, leading to non- sustainable and inefficient resources (climate and land) utilization.

A strategy for sustainable management and effective utilization of the resources, technically and financially sound to farmers for improving and maintaining soil fertility is very scant but badly needed. Organic fertilizers such as farmyard and green manures are among the options that sound good for farmers under such difficult circumstances. The potential of using farmyard manure as a fertilizer is high, but due to high shortage of fuel wood in the country particularly in the high lands cow dung is used for fuel purpose (FAO, 1986).

Green manure is one aspect of fertilizer which can be grown over a season when a farm is not in use and later tilled into the soil to improve the fertility. It has multibenefits. Among others release nutrients upon decomposition, improves soil structure, suppressing weeds, protects the soil surface from erosion during erosion prone periods of the year, stimulates decomposing of organic matter (Cavigelli and Thien, 2003) and improves soil water holding capacity.

Analyzing the opportunities where to use green manure is a critical step for its future success and scaling up. North western Ethiopia is characterized by uni-modal rainfall pattern and the rainy season extends from May through November. Annual crops are dominantly grown with this extended rainfall. There are three opportunities that green manure could be introduced to the farming system:

#### **? cW\_ ^ R\_f cVTe` a W]] h Z\_XSRc]Vj YRcgVde**

Crops like barley physiologically mature starting from the end of August and this is a good opportunity to grow green manuring crops without affecting the main crop. After barley harvest farmers grow lupine, barley and noug with residual moisture. Sometimes, they also leave the land uncovered. The rationale of lupine growing with residual moisture is to improve the fertility of the soil and reducing the cost for chemical fertilizer. Otherwise market price of lupine is very low (as low as 25 birr/100 kg). Lupine has the ability to fix atmospheric nitrogen and make P-available in high p fixing soils (Cavigelli and Thien, 2003). Using this crop (lupine) as a green manure is therefore untouched opportunity. Maximum fixation of legumes is at 50% flowering and hence sufficient biomass of lupine is expected for the green manure.

#### **A RcVRdV a VcZV TZ\_XW]] h ZX**

According to Yihenew (2002) high - mid altitudes areas of the north-west Ethiopia are dominated by acid soils and its extent is increasing. It is a challenge of the country since productive soils are dominated by acidity that is why the Ministry of Agriculture and Rural Development recently launched acid soil management strategies. Integrated way of approach may be effective to reclaim acid soils. Fallowing is very common for areas such as Injibra which is affected by acidity and it is possible introduce green manuring crops in the main season since the land is left fallow in some years.

#### **? c` h Z\_XWde Xc` h Z\_XXcW\_ ^ R\_f cVa]R\_edSWcVeW]] h ZX**

Tef is a leading cereal crop in area coverage in north-western parts of the country. It needs fine seed bed, trampling by livestock and planted very lately. Soil erosion by water from tef field is very high (FAO, 1986) since there is little soil cover during peak rainfall months (June, July and August). There is unutilized time gap between tef sowing and onset of the rainfall. This time gap can be used for growing green manuring



plant species to improve soil fertility and reduce soil erosion. Research should focus on identifying fast growing species adapting to this short time gap. Taking the above backgrounds as a spring board a research was carried out with the objective of assessing the potential of green manure intervention during off season upon subsequent crop yield.

#### **D ReVcZjdR UD VcY Ud**

To assess the potential of green manure two sets of experiments were designed  
**JVe`\_V6** Lupine as a green manure following barley harvest was evaluated on farmers' field for two years on different sites at Mecha Woreda\* As shown in Table 1, field covered with barley was selected during August and that field was divided into three treatments: Fallowing, lupine for green manure and lupine for grain.  
 At 50% flowering stage lupine for green manure was under plowed while lupine for grain yield allowed to grow until full maturity and grain yield data was collected. Maize (var. BH 540) was planted as a test crop at the start of the rainy season and all agronomic and related data were collected.

Table 1: Brief summary of activities

Month	Activities		
June-August	Selection of Barley field		
September-December	Fallowing	Plants Lupine for green manure	Plants Lupine for grain
January-May	plowing	under plowing	plowing
June-November	Growing Maize	Growing Maize	Growing Maize

**JVe ch`6** to evaluate the possibility of green manure intervention with late plating types of crops such as teff the on-station research was carried out at Adet Agricultural Research center for two years using vetch and lupine as green manuring crops. Three treatments were used for the experiment: Control, green manure with lupine and green manure with vetch.

As soon as the rainy season started, green manure plants (vetch and lupine) were sown. Keeping the right time for teff planting, green manuring plants were under plowed before seven days of tef sowing. For both sets of experiments the collected data was subjected to statistical analysis with Mstat C-computer program.

#### **I Vff jedR\_U < ZIf dZ\_d**

Encouraging results were obtained for both sets of the experiments. It was obtained in agreement with the hypothesis that grain yield of the respective crop could be increased with green manure.

For set one experiment, the lupine green manure is reached for its maximum nitrogen fixation (50% flowering) in the growing season and the soil moisture was sufficient enough to grow sufficient biomass after barley harvesting.

The effect of lupine green manure was highly significant upon maize grain yield (Table 2). The highest grain yield was recorded from growing maize after growing lupine as green manure and the least from planting maize after following.

Table: 2 Maize responses for green manure

KcVR^ V_ed	Grain yield kg/ha	
	OVRc	
	2000	2001
1. Fallow	2790	3316
2. Green manure	3683	4195
3. lupine for grain	3232	3933
LSD	1330	454.3
Cv	37.2	15.2

Yeshanew and Asgelilel (1998) obtained similar results using lupine as a green manure for wheat in the main season. Since the population pressure of the country is very high and farmers have limited plots of land, such system will not allow them to grow green manure plants alone during the main season. But the present research result does not have any opportunity cost. The result of the experiment was also in agreement with the results of pot experiments of lupine by Cavigelli and Thien (2003). Swale, J. (1998) followed similar trends to this experiment for the production of wheat by green manure, but he recorded in significant yield increase with short time gaps and high yield with long time gaps. Therefore the result of the experiment was reliable and acceptable from both technical and financial point of view. As shown from Table 2, not only green manure with lupine but also lupine for grain was having a significant positive effect on the subsequent crop (maize) supporting the hypothesis that farmers grow lupine for the sake of improving the fertility of their soil. Increment of maize by lupine intervention either as a green manure or grain resulted mainly from the contribution of major nutrients (nitrogen and phosphorus). Because lupine is a nitrogen fixing cool season legume. Nitrogen is added to the soil through nodules, leaf and root decompose. The soil where the experiment executed was Nitisols which has strong phosphorus fixation capacity. Lupine has a special adaptation to such soils to make available use the fixed phosphorus. Cavigelli and Thien (2003) found a higher P-uptake from lupine as compared to other tested crops.

For set two experiment, it was possible to grow sufficient biomass production of green manure crops (lupine and Vetch) before planting time of tef. However, the green manure crops were not allowed to reach maximum nitrogen fixation (50% flowering). It was because these green manure crops should not be given priority to major crop and tef planting time reached before the green manures flower. Nevertheless there was significant differences between treatments for grain yield as shown from Table 3.

Table 3: Response of tef for green manure

KcVR <sup>e</sup> V <sub>ed</sub>	? cR <sub>j</sub> ZJU \$ X+R%
1. Farmers' practice	1404
2. Lupine green manure	1608
3. Vetch green manure	1722
LSd	230
Cv.	9

The result obtained was in agreement with the hypothesis that there is possibility of green manure production in the time gap between onset of rainfall and tef sowing and thereby increase crop yield\* Green manure crops trap nutrients that were ready to be washed away by runoff and were made available to the intended crop upon under plowing.

#### ; ` \_Tjf dZ\_dR UI VT ^ ^ V\_URZ\_d

The hypothesis that green manure could be grown in north western Ethiopia after barley harvest without affecting the major crop was in line with the result\* The moisture was sufficient to grow lupine as a green manure after barley harvest. Maize grain yield was increased from lupine plots using it either as a green manure or as a grain. Lupine has low grain yield per unit area and the market price of lupine is very low. On the other hand, the result from the experiment showed higher yield of maize from green manure plots of lupine than using it as for grain. The practice is feasible from both technical and economical point of. The result from set two was also encouraging and in line with the hypothesis. From both species used for green manure there was higher grain yield of tef than control (farmers' practice). Problems related to tef production especially associated with soil erosion might be alleviated by this practice. An increment of two quintals of tef is very high taking the average productivity of tef per unit area and its market price. Generally, for both systems there was statistically significant difference between treatments and higher yield was observed from using green manure.

From the results of the experiment, it is possible to recommend the following:

- Following barley harvests the land should be covered with lupine with seed rate of 250 kg/ha whatever the subsequent crop. Lupine as green manure should be incorporated at 50% of flowering since it is the maximum time for nitrogen fixation.
- Before tef sowing : lupine at a rate of 250 kg/ha and vetch at a rate of 60 kg/ha should be applied as soon as the rainy season starts and incorporated 8-10 days before tef sowing.
- Future research for both systems should direct in finding fast growing green manuring crops with high biomass yield and nutrient content.
- In highland areas like Injibara, where fallowing is a common practice, intensive utilization of green manuring technology during the fallowing period should be intensified

## **I WwV TVd**

- Cavigelli, Michel A. and Thien, Steve J. 2003. Phosphorus Bioavailability following Incorporation of Green Manure Crops. *Soil Science society of America Journal* 67: 1186-1194(2003).
- FAO (Food and Agriculture Organization of the United Nation).1986. Ethiopian Highland Reclamation Study. Final Report Volume 1.Report prepared for the Government of Ethiopia by the Food and Agriculture Organization of the United Nations
- Lakew Desta, Menale Kassie, Benin S. and Pender J. 2000.Land degradation and strategies for sustainable Development in the Ethiopian highlands: Amhara Region. Socio-economics and policy research Working Paper 32. ILRI (International livestock Research Institute), Nairobi, Kenya.122pp.
- Makken, F.1993. Over view of the Agricultural sector in sub-Saharan Africa. The role of plant nutrients for sustainable food crop production in Sub-Saharan Africa/ed. H.Van Reuler, and W.H.Prins.
- Siwale, J.1998. Sustainable Dry land Wheat production through Green manuring. The Tenth Regional Wheat Workshop for Eastern Central and Southern Africa. University of Stellenbosch, South Africa, 14-18 September, 1998.
- Smaling, E.M.A. 1993. Soil nutrient Depletion in Sub-Saharan Africa. The role of plant nutrients for sustainable food crop production in Sub-Saharan Africa/ed. H.Van Reuler, and W.H.Prins.
- Yeshanew Ashagrie and Asgelil Dibaba.1998.The Effect of Green Manuring and Application of Fertilizer on the Yield of Bread Wheat at Adet In North-Western Ethiopia. The Tenth Regional Wheat Workshop for Eastern Central and Southern Africa. University of Stellenbosch, South Africa, 14-18 September, 1998.
- Yihenew G. Selassie. 2002. Selected chemical and physical of soil of Adet research center and its testing sites in north-western Ethiopia. *EJNR: Ethiopian Journal of Natural Resources* 4(2):199-215

**J` Z KVde : RdMUE R\_UG>VceZZKc I ReVI VI ^ ^ V\_URZ\_d  
`WD RkVWc M Vde 9 ^ YRcR**

Yihenew G.Selassie, Tadele Amare and Tesfaye Feyissa  
Adet Agricultural Research Center, P.O.Box 8, Bahir Dar, Ethiopia

## **9 Sdecrle**

With the prime objective of developing soil test based N and P fertilizer rate recommendations of maize for West Amhara, field experiments were conducted in two years time on 24 sites. At each site, both N and P experiments were conducted. The treatments included five rates of N fertilizer (0, 30, 60, 90 and 200 kg N ha<sup>-1</sup>) and five rates of P fertilizer (0, 30, 60, 90 and 150 kg P<sub>2</sub>O<sub>5</sub> ha<sup>-1</sup>) were arranged in a randomized complete block design with four replications. After maturity, yields and yield components data were collected. Soil parameters determined for indexing availability of nitrogen were organic matter content, total N, NH<sub>4</sub>-N, NO<sub>3</sub>-N, inorganic N (NH<sub>4</sub>+NO<sub>3</sub>-N), inorganic N production on aerobic incubation, and ammonium-N released on autoclaving with dilute calcium chloride. For soil P analysis Bray-1, Bray-2, Olsen, Mehlich-1, anion exchange resin and extraction with 0.01 CaCl<sub>2</sub>. Parameters of the Quantity/Intensity relationships were also determined. Reliable methods were identified in the first year by fitting

relative grain, relative dry biomass and N yields in a double log curvilinear regression model and those availability indices giving superior correlation were selected. In the second year, the selected methods were retested and to confirm their reliability. Consequently, nitrogen and phosphorus availability indices that were found most reliable and grain yield data were fitted into the Mitscherlich-Bray model.

Results of the experiments revealed that organic matter, total N, and NO<sub>3</sub>-N were the most reliable N availability indices. Similarly, Bray-2 and Olsen methods gave the most reliable P available indices. In the second year cropping season, the first two indices for nitrogen and the above two indices for phosphorus were retested with field experiment data collected from 4 locations. Results of the two years (24 locations) experiments indicated that the tested methods give reliable availability indices. Hence, from the two years' data the equations developed for estimating N fertilizer requirements of maize were: (a)  $\log(100 - y) = 2 - 0.1343b - 0.006419x$  and (b)  $\log(100 - y) = 2 - 2.2088b - 0.006479x$  for organic matter and total N, respectively, where y was relative yield goal, b was N availability index expressed as % and x was the N fertilizer requirement. Similarly, the equations developed for estimating P fertilizer requirements of maize from soil analysis were: (a)  $\log(100 - y) = 2 - 0.1468b - 0.007546x$  and (b)  $\log(100 - y) = 2 - 0.1167b - 0.007546x$  for Olsen and Bray-2 methods, respectively, where y was desired relative grain yield (%); b was soil P availability index (mg kg<sup>-1</sup>); and x was P fertilizer requirement (kg ha<sup>-1</sup>).

#### A ec` U TeZ`

In West Amhara, population growth is rapid and there is a rapidly growing demand for food. Therefore, cultivation of subsistence crops must be stimulated and production augmented in a sustainable way. The trend in all research endeavors including research on soil nutrients, therefore, is going through a development process away from agricultural production towards production (Smaling and Oenema, 1998). Among others, mineral nutrition is becoming one of the most important factors for increasing maize production in Northwestern Ethiopia. Unfortunately, many soils of Ethiopian highlands are inherently poor in available plant nutrients and organic matter (Tekalign ., 1988). Murphy (1963) conducted a survey or rapid appraisal work to assess the fertility status of Ethiopian soils and concluded that the major part of Ethiopian soils is deficient in nitrogen and phosphorus. Hence, farmers who attempted to grow crops without or with marginal fertilizer application could not produce enough even to feed their own family for one year.

As in other soils of Ethiopia, nitrogen is probably more often deficient than any other essential element in Alfisols, mainly because organic matter of these soils is not preserved (Mesfin, 1998). In addition to this, the cereal dominated cropping systems, aimed at meeting the farmers' subsistence requirements, coupled with low usage of chemical fertilizers have led to the widespread depletion of soil nitrogen in the maize growing areas of Ethiopia. Moreover, the heavy rains during the early part of the main cropping season (June-August) cause substantial soil nutrient losses due to intensive leaching and erosion (Amsal and Tanner, 2001).

Phosphorus is also of primary concern in the appraisal of the soil resources of Ethiopia (Miressa and Robarge, 1996) since most of the soils on the highland plateau are reported to be deficient in phosphorus (Asnakew ., 1991; Desta, 1982; Tekalign ., 1988). Phosphorus is one of the most limiting elements in the majority of the Alfisols of Ethiopia. In P-deficient soils, crops usually recover less than 10 percent of the applied amount of phosphorus in the first season, even if they respond well and the total recovery

after four years is often only 20-30 percent (Russel, 1972). In addition to the inherently low available P content, the high P fixation capacity of these soils made the problem complex. Tekalign and Haque (1987), and Taye (1998) have reported a sorption range of 150-1500  $\mu\text{g g}^{-1}$  in several Alfisols of Ethiopian highlands. Therefore, following nitrogen, phosphorus is the most limiting nutrient in the tropics (Sanchez, 1976). Deficiency of nitrogen and phosphorus in these soils eventually led to severe yield decline in Northwestern Ethiopia.

The role of chemical fertilizers in increasing yield is evident. Fertilizers accounted for more than 50% of the increase in yield (FAO, 1984). Experience has shown that in seasons with good rain, farmers of Northwestern Ethiopia managed to produce surplus yield through fertilization. The rates applied, however, should meet the demand of the crop, but should not exceed the demand to any major extent. For this purpose, in Ethiopia, some flat fertilizer recommendations have been developed and introduced into the extension system. This approach, however, had shortcomings in extrapolating the results to farmers' fields, because the available nutrient status on the experimental fields were either lower than, equal to or higher than that of the farmers' fields. Hence, fertilizer recommendations should take into account the available nutrient already present in the soil (Mengel, 1982). The objective of this study was, therefore, to develop soil test based N and P fertilizer recommendations for maize growing in West Amhara.

#### **D**

The experiment was conducted for two years in 2002/2003 and 2004/2005 cropping seasons in West Amhara. To select the experimental sites, in the first year 52 composite soil samples were collected from farm2 s

7	1955.8	11°45.7'N	37°32.4'E	3.1	3.19	8.02	4.99	7	27	66	Clay
8	1969.8	11°46.8'N	37°33.2'E	2.3	3.11	10.73	4.83	9	27	64	Clay
9	1916.8	11°44.4'N	37°31.7'E	8.1	2.31	11.41	5.26	55	21	24	SanCL
10	2048.7	11°24.8'N	37°24.8'E	1.1	3.93	9.43	5.25	9	25	66	Clay
11	2067.6	11°25.0'N	37°07.9'E	3.5	4.22	7.59	5.25	15	49	36	SilCL
12	2039.8	11°24.8'N	37°07.4'E	0.2	4.08	6.66	5.05	9	25	66	Clay
13	2038.9	11°24.6'N	37°07.1'E	0.3	4.24	6.48	5.13	11	23	66	Clay
14	2002.7	11°21.6'N	36°58.1'E	1.6	5.56	10.96	5.01	13	23	64	Clay
15	1900.0	10°80.0'N	36°85.0'E	5.0	6.06	7.96	5.75	11	21	68	Clay
16	2150.7	10°42.7'N	37°05.6'E	1.8	3.99	16.04	5.78	15	25	60	Clay
17	2106.3	10°42.2'N	37°06.3'E	5.2	4.51	9.48	5.43	9	21	70	Clay
18	1897.9	10°40.8'N	37°16.4'E	2.3	4.33	9.48	5.63	11	23	66	Clay
19	1888.4	10°40.5'N	37°16.4'E	2.9	4.12	4.14	5.42	11	23	66	Clay
20	1882.0	10°40.9'N	37°19.0'E	0.6	3.71	2.54	5.28	11	23	66	Clay
Year II											
1	2243.1	11°17.3'N	37°28.8'E	2.6	2.13	9.56	5.21	5	24	71	Clay
2	2150.7	10°42.7'N	37°05.6'E	1.8	2.25	20.99	5.78	13	25	62	Clay
3	2106.3	10°42.2'N	37°06.3'E	5.2	2.14	6.84	5.43	8	20	72	Clay
4	1882.0	10°40.9'N	37°19.0'E	0.6	2.01	4.92	5.28	10	22	68	Clay

### >ZJU]Rj `f eR UVaVcZ V\_eR] UVWZ

The distance between rows was 75 cm and the distance between plants within a row was 30 cm. The distance between blocks was 1.5m. No space was left between plots in each replication.

The treatments for Experiment 1 were 0, 30, 60, 90 and 200 kg N ha<sup>-1</sup>. For this experiment, half of the nitrogen fertilizer as urea (46-0-0) for each treatment were applied at planting by banding along one side of the seed row at a distance of about 10 cm below and 5 cm aside the seeds. The remaining nitrogen was side dressed at 35 days after emergence. To each treatment, 120 kg P<sub>2</sub>O<sub>5</sub> ha<sup>-1</sup> as triple superphosphate (0-46-0) was added as basal fertilizer to minimize the effect of the law of the minimum

The treatments for Experiment 2 were 0, 30, 60, 90 and 150 kg P<sub>2</sub>O<sub>5</sub> ha<sup>-1</sup>. For this experiment, all of the phosphorus fertilizer for each treatment was applied at planting by banding along one side of the seed row at a distance of about 10 cm below and 5 cm aside the seeds. Triple superphosphate was used as source of phosphorus. A fixed rate of N fertilizer (150 kg N ha<sup>-1</sup>) was added to all plots. The N fertilizer in the form of urea was added in split, half at planting and the remaining at 35 days after emergence.

Both Experiments were arranged in randomized complete block design with five treatments and four replications.

### J` ZJR` a]V; `]V]eZ \_R\_U9 \_Rj dWc A\_U] Z\_X9 gR]RSZ]j `WE R\_UG

In the first cropping season, from each replication of the selected locations, one composite soil sample was collected from the top 0 - 20cm soil layer at planting and before fertilizer application. The collected samples were air-dried under the shade and crushed to pass through 2 mm sieve. The following soil analyses were conducted: determination of organic matter content according to the Walkley-Black procedure (Nelson and Sommers, 1982); total N determination by the Kjeldahl method (Bremner and Mulvaney, 1982); NO<sub>3</sub>-N, NH<sub>4</sub>-N, and NO<sub>3</sub>+NH<sub>4</sub>-N determination by steam distillation as outlined by Keeney and Nelson (1982); aerobic incubation and estimation of inorganic-N production as outlined by Ryan (1971), and determination of ammonium released on autoclaving with dilute calcium chloride as outlined by Keeney (1982).

Indexing availability □ a n ca llin □ ix 0



Results of the first year experiment revealed that all the nitrogen availability indices included in the experiment, except available  $\text{NH}_4\text{-N}$ , showed highly significant correlation ( $p < 0.01$ ) with relative grain yield (Figure 1). Relative dry biomass yield and N uptake also correlated highly significantly with all the indices except  $\text{NH}_4\text{-N}$ , which were significant at 5% probability level. The highly significant correlation between  $\text{NH}_4+\text{NO}_3\text{-N}$  content and relative yield values was, however, attributed to the  $\text{NO}_3\text{-N}$  content than to the  $\text{NH}_4\text{-N}$  content, because the later alone did not have significant correlation with relative grain yield and correlated at lower level of significance ( $p = 0.05$ ) with relative dry biomass and N yields. This suggested that inclusion of  $\text{NH}_4\text{-N}$  in inorganic N content analysis as an index rather reduces reliability. Generally, analytical indices that involve measurement of  $\text{NH}_4\text{-N}$  exhibited rather diminished correlation coefficients and, in some cases, lower level of significance. Comparing the obtained correlation coefficients of the relationships between availability indices and relative grain yield,  $\text{NO}_3\text{-N}$  was found to be superior to the other indices followed by organic matter and total N. However, the correlation coefficients between availability indices and relative dry biomass yield as well as N uptake were superior for organic matter followed by  $\text{NO}_3\text{-N}$  and total N. The overall trend indicated that organic matter was superior to  $\text{NO}_3\text{-N}$ , and the later was superior to total N. Therefore, organic matter content, total N and  $\text{NO}_3\text{-N}$  were selected as reliable indices of availability of N.

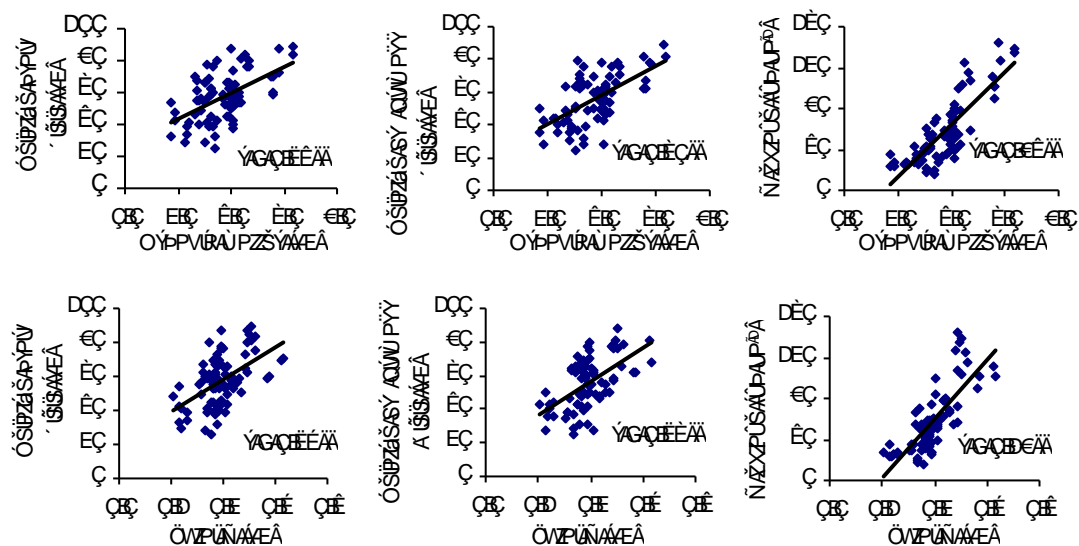

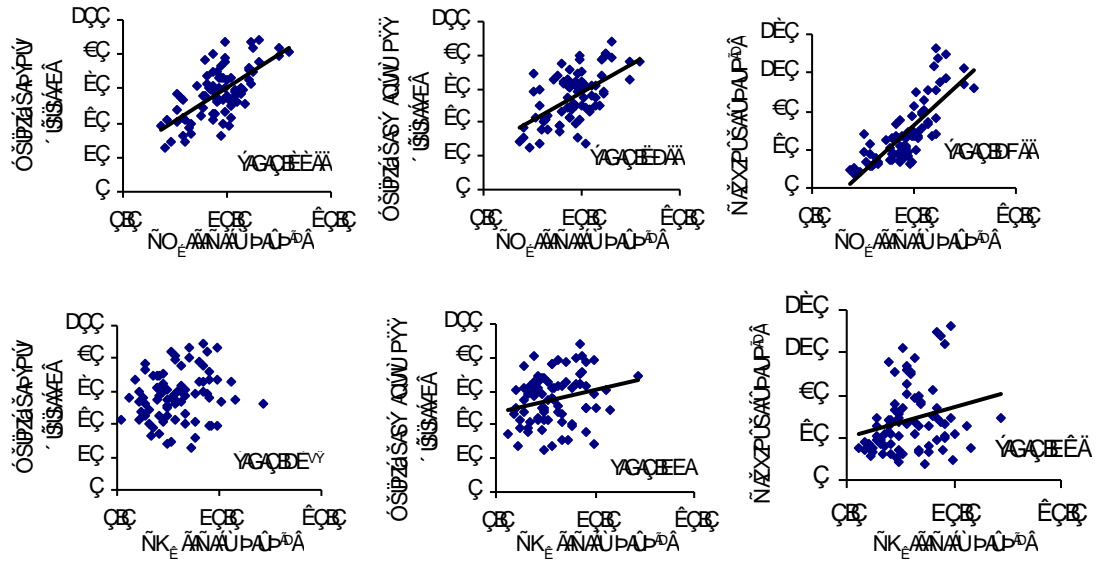
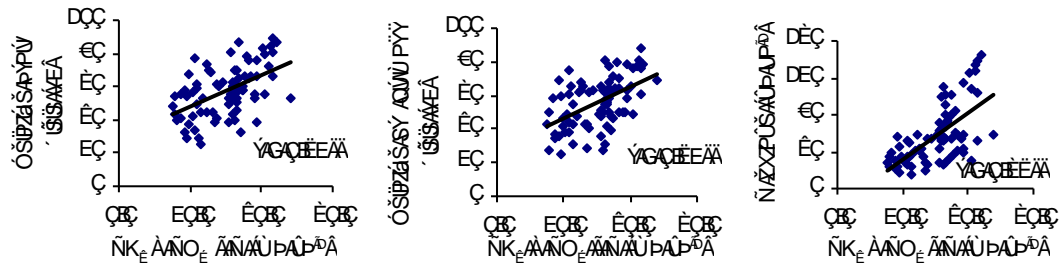

Figure 1: Relationships between availability indices and relative grain, relative dry biomass and N yields (\*, \*\* significant at 5% and 1% probability levels, respectively; <sup>ns</sup> non-significant at 5% probability level; n = 80)



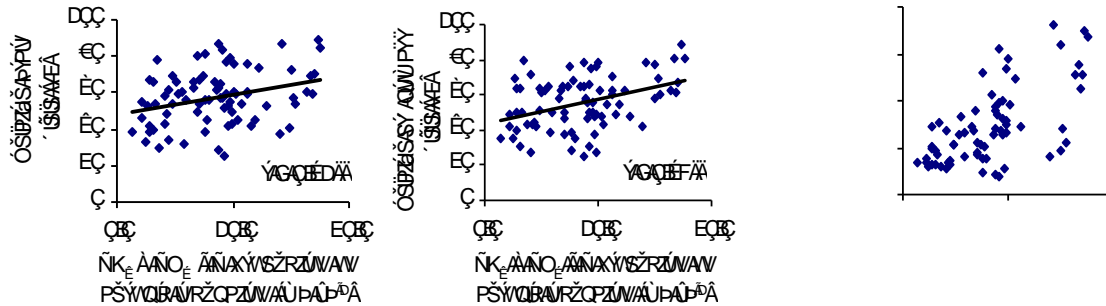

Figure 1 (contd.): Relationships between availability indices and relative grain, relative dry biomass and N yields (\*, \*\* significant at 5% and 1% probability levels, respectively; <sup>ns</sup> non-significant at 5% probability level; n = 80)

In the next cropping season organic matter and total N were retested for their reliability as index of availability of N. Results showed that even though the field experiment was conducted on 4 locations with four replication on each location, the result showed that the two indices were reliable.

Figure 2: Relationships between availability indices and relative grain yield (\*\* significant at 1% probability levels; n = 16)

Results of the P experiment of the first cropping season indicated that, all indices except the parameters of the quantity/intensity relationships, highly significantly ( $P < 0.01$ ) correlated with relative grain and dry biomass yields (Figure 3). The relative yield curves have shown more typical Mitscherlich type yield trend for Olsen, Bray-2, Mehlich-1, Bray-1 and AER methods. With other availability indices, the relative yield curves had

either linear trend or had no significant relationship. This was especially true for those methods that extracted low amount of P from the soil. It was observed, however, that P uptake relatively poorly correlated with availability indices when compared with other yield parameters, and Mitscherlich type yield trend was not obtained. Among the parameters of the quantity/intensity curves, EPC (the x-intercept in the Q/I graph) had no significant relationship with relative grain yield but had significant relationship with relative dry biomass yield ( $p < 0.05$ ) and P uptake ( $p < 0.01$ ). Labile P (y-intercept in the Q/I graph) provided significant correlation coefficients at rather lower level of significance ( $p < 0.05$ ) with relative grain yield and relative dry biomass yield. PBC ( $\Delta Q/\Delta I$  in the Q/I graph) exhibited negatively significant ( $p < 0.05$ ) relationship with relative grain yield ( $r = -0.26^*$ ); and non-significantly negative relationship with relative dry biomass yield ( $r = -0.18^{ns}$ ) and P uptake ( $r = -0.17^{ns}$ ). Generally, only indices from Olsen and Bray-2 methods exhibited relatively higher correlation coefficient values exceeding 0.5 with relative grain and dry biomass yields. From the above, it is possible to recommend that Olsen and Bray-2 P can be used as reliable indices of availability of P.

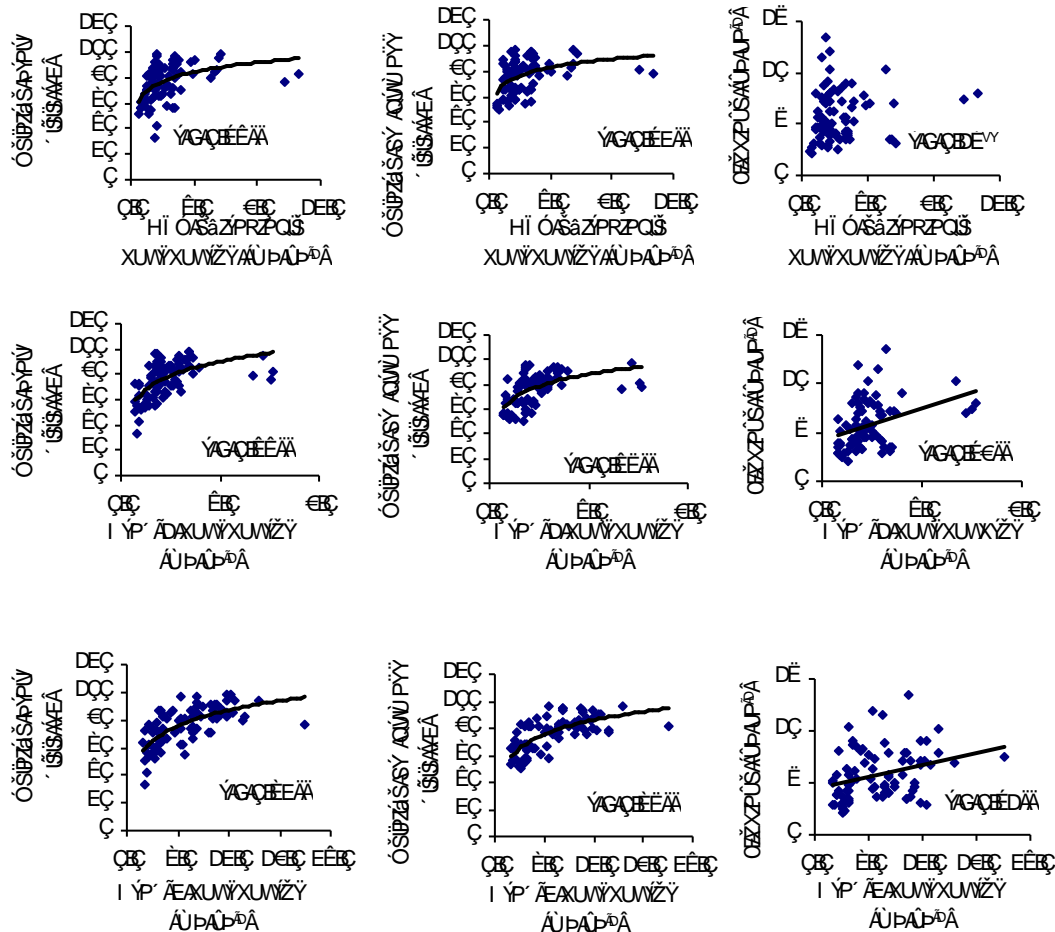

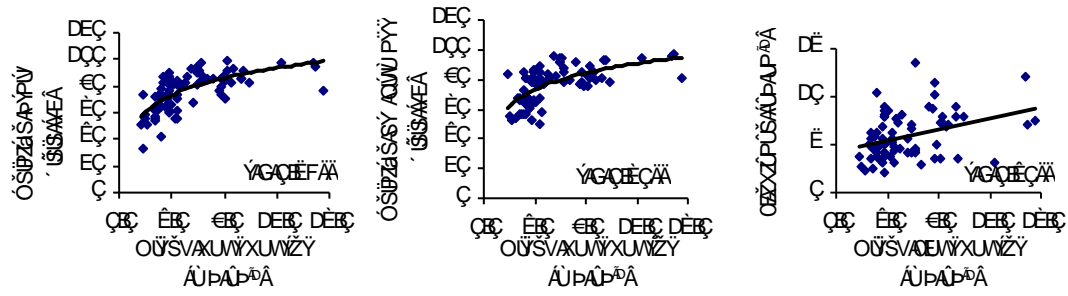
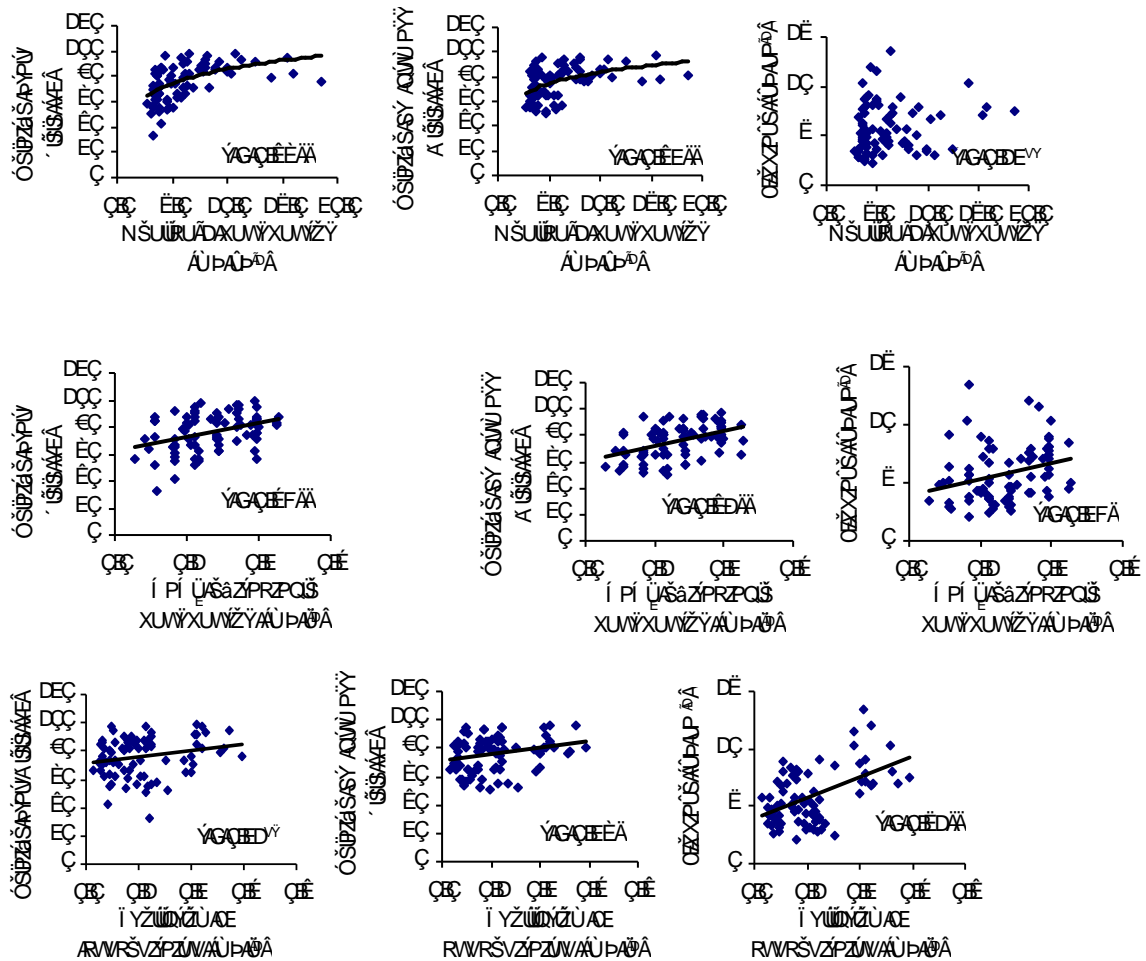

Figure 3: Relationships between P availability indices and relative grain, relative dry biomass and P yields (\*, \*\* significant at 5% and 1% probability levels, respectively; <sup>ns</sup> non-significant at 5% probability level; n = 80)



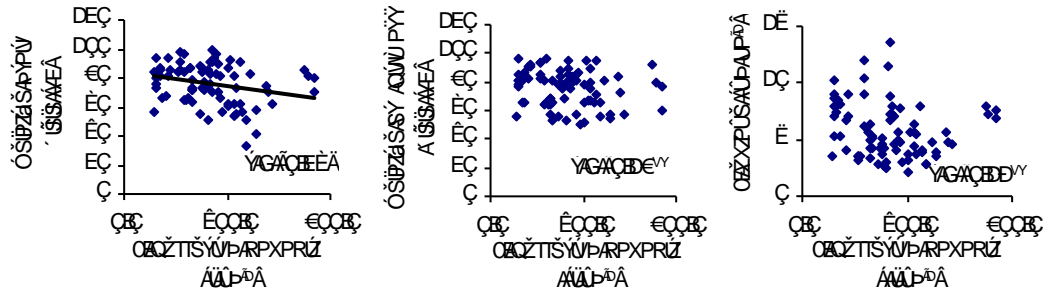

Figure 3(contd.): Relationships between P availability indices and relative grain, relative dry biomass and P yields (\*, \*\* significant at 5% and 1% probability levels, respectively; <sup>ns</sup> non-significant at 5% probability level; n = 80)

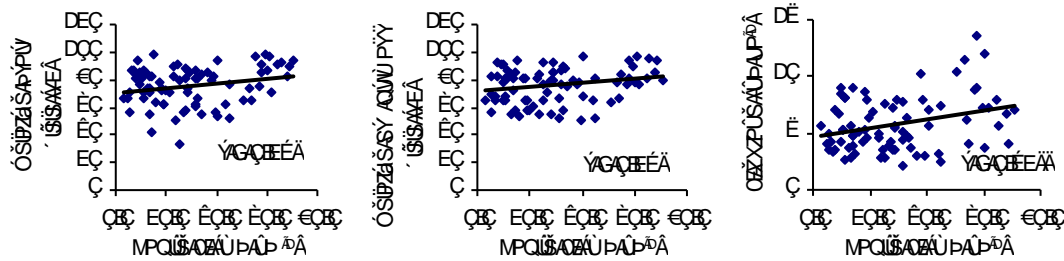

Figure 3 (contd.): Relationships between P availability indices and relative grain, relative dry biomass and P yields (\*, \*\* significant at 5% and 1% probability levels, respectively; <sup>ns</sup> non-significant at 5% probability level; n = 80)

In the next cropping season Bray-II and Olsen P were retested as indices of availability of P. Results of the experiment indicated that both indices gave Mitscherlich type curve which is the most accepted type of response of crops to fertilizer application (Figure 4).

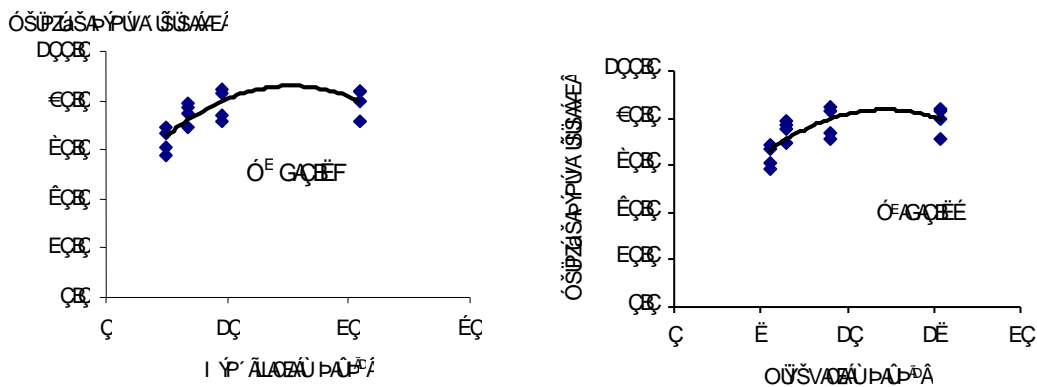

Figure 4: Relationships between P availability indices and relative grain yields

**=bf ReZ\_dWc VbZ ReZ XE R\_UG WceZKc cReVd W ^ d f aVcZ c RgRZRSZLj Z\_UZVd**

The Mitscherlich-Bray equations for estimating nitrogen fertilizer requirements of maize from soil analysis for organic matter and total N are shown in Table 2.

Table 2: Equations for estimating nitrogen fertilizer requirements of maize from soil analysis results of reliable methods

Method No.	Availability index	Unit of index	Equation <sup>1/</sup>
1	Organic matter <sup>2</sup>	%	$\log(100 - y) = 2 - 0.1343b - 0.006419x$
2	Total N	%	$\log(100 - y) = 2 - 2.2088b - 0.006479x$

<sup>1/</sup> y = relative yield goal (as % of maximum yield); b = N availability index obtained from soil analysis (%); x = N fertilizer requirement (kg ha<sup>-1</sup>); <sup>2</sup> Organic matter (%) = Organic carbon (%) x 1.726

From the models it was possible to make predictions that for a unit increase in soil organic matter content (%), the amount of N fertilizer to be applied shall be reduced by 20.9 kg ha<sup>-1</sup>, taking 94% as optimum relative yield goal. Similarly, a 0.1% increase in total N content shall reduce the fertilizer rate by 31.7 kg ha<sup>-1</sup>. The maximum fertilizer rates that would be applied had indices of organic matter and total N were zero were 190.37 and 188.61, respectively (Appendix Table 1 and 2). This indicates that the developed Mitscherlich-Bray equations give equivalent fertilizer recommendations.

Equations for estimating P fertilizer requirements of maize from soil analysis results of the reliable methods are presented in Table 3. Coefficients for indigenous soil P (c<sub>1</sub>) and fertilizer rates (c) were calculated as mean of 80 and 280 data points, respectively. The second year data were not used in calculating the coefficients because they reduced the reliability of the model. However, the data was used to verify the reliability of the indices. The Olsen method extracted less P than Bray-2 from most of the soil samples analyzed and eventually the c<sub>1</sub> value was higher for the former than the later. From the models it was possible to make predictions that for a unit increase in soil P concentration (mg kg<sup>-1</sup>) measured by Olsen and Bray-2 methods, the amount of P fertilizer to be applied shall be reduced by 19.4 and 15.4 kg P<sub>2</sub>O<sub>5</sub> ha<sup>-1</sup>, respectively, taking 98% as optimum relative yield goal. Higher yield goal was used to calculate the mineral fertilizer equivalency values for the indices because high P deficiency and fixation is expected on Alfisols of West Amhara which requires higher amount of nutrient application.

Table 3: Equations for estimating phosphorus fertilizer requirements of maize from soil analysis results of reliable methods

Method	P availability index	Unit of index	Equation <sup>1/</sup>
Olsen	Olsen P	mg kg <sup>-1</sup>	$\log(100-y) = 2 - 0.1468b - 0.007546x$
Bray-2	Bray-2 P	mg kg <sup>-1</sup>	$\log(100-y) = 2 - 0.1167b - 0.007546x$

<sup>1/</sup> y = relative yield goal (as % of maximum yield); b = P availability index obtained from soil analysis (mg kg<sup>-1</sup>); x = P fertilizer requirement (kg P<sub>2</sub>O<sub>5</sub> ha<sup>-1</sup>).

**I VJZSZj `WYVbf ReZ\_d**

Reliability of the equations was verified by comparing the actual grain yields obtained from the experimental plots with predicted yields by the developed equations. Simple linear regression technique was employed to see the relationships between actual grain yields obtained from the experimental plots and predicted grain yields by the developed equations. All the equations gave grain yield predictions that were highly significantly ( $P < 0.01$ ) correlated with actual yields (Figure 5).

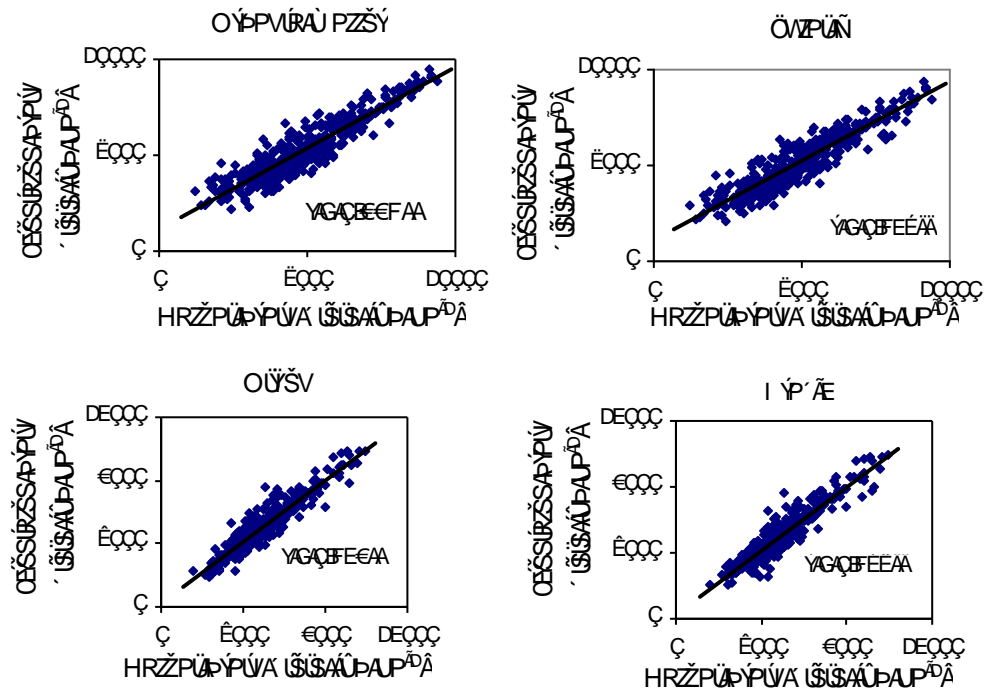

Figure 5: Relationships between actual maize grain yields and the yields predicted by the equations for the specified methods (\*\* significant at 1% probability level)

**< Vêc^ Z ReZ\_ `WYVtZIR d Z E R UGT \_TV ecReZ\_**

The Cate-Nelson graphical technique (Cate and Nelson, 1965) was compared with the developed equations in determining the P critical level. The former method involves superimposing vertical and horizontal lines on a scatter diagram so as to maximize the number of points in the positive quadrants. The vertical line divides the data into two classes (high probability of response and low probability of response). The point where the vertical line intersects the x axis has been termed as the critical level.

Based on this, the N availability indices of the experimental sites obtained by the three reliable methods were generally low enough to identify the critical N levels using the graphical technique of Cate and Nelson (1965). Nevertheless, the developed equations have provided extrapolated critical N levels (N levels at which application of fertilizer is not required) at planting to be 9.01% and 0.595% for organic matter and total N, taking 94% as optimum relative yield goal.



The critical P concentration beyond which applied fertilizer becomes non-responsive was identified to be 11.6 and 14.6 mg kg<sup>-1</sup> for Olsen and Bray-2 methods, respectively taking 98% as optimum relative yield goal. The Cate-Nelson technique also gave comparable result. It is apparent that in acidic soils like Alfisols of the study area, the inherently low P content coupled with high P fixation capacity makes application of larger amount of P fertilizer of paramount importance.

**;`\_Tlf dZ\_d**

From the results of the experiment it is possible to draw the following conclusions:

- From the soil analysis methods incorporated in the experiment, determination of organic matter and total N were found to give reliable N availability indices. Similarly, Bray-2 and Olsen methods were found to be superior in providing reliable indices of indigenous P availability in the soil.
- The Mitscherlich-Bray equations developed for indices of organic matter and total N and the two reliable soil P extraction methods (Bray-II and Olsen) were statistically proven to provide reliable estimates of P fertilizer requirements of maize on Alfisols of Northwestern Ethiopia.
- The extrapolated critical levels beyond which application of N fertilizers becomes non-responsive were identified to be 9.01% and 0.594% for organic matter and total N, respectively measured at planting. Similarly, the critical P concentration beyond which applied fertilizer becomes non-responsive was identified to be 11.6 and 14.6 mg kg<sup>-1</sup> for Olsen and Bray-2 methods, respectively.

**I W&V T&I**

Amsal, T. and D. G. Tanner. 2001. Effects of fertilizer application on N and P uptake, recovery and use efficiency of bread wheat grown on two soil types in central Ethiopia. *Eth. J. Nat. Res.* 3 : 219-244.

Asnakew, W., T. Mamo, M. Bekele and T. Ajama. 1991. Soil fertili

- Methods of Soil Analysis. Part 2: Chemical and Microbiological Properties. Agron. 9. Madison, Wisconsin.
- Keeney, D. R. and D. W. Nelson. 1982. Nitrogen-inorganic forms, pp. 643-698. A. L. Page ed. Methods of Soil Analysis. Part 2: Chemical and Microbiological Properties. Agron. 9. Madison, Wisconsin.
- Kpombrekou, K. A. and M. A. Tabatabai. 1997. Effect of cropping systems on quantity/ intensity relationships of soil phosphorus. Soil Sci. J. 162 : 56-68.
- Mengel, K. 1982. Factors of plant nutrient availability relevant to soil testing. Plant Soil 64 : 129-138.
- Mesfin, A. 1998. Nature and Management of Ethiopian Soils. Alemaya University of Agriculture. Alemaya, Ethiopia. 272 p.
- Miressa, D. and W. P. Robarge. 1996. Characterization of organic and inorganic phosphorus in the highland plateau soils of Ethiopia. Commun. Soil Sci. Plant Anal. 27 : 2799-2814.
- Murphy, H. F. 1963. Fertility and other data on some Ethiopian soils.
- B. Taye. 1998. Soil Fertility Research in Ethiopia. Paper presented at the Soil Fertility Management Workshop. April 21-

Tekalign, M., I. Haque and C. S. Kamara. 1988. Phosphorus status of some Ethiopian highland Vertisols, pp. 232-252. In S. C. Jutzi ed. Management of Vertisols in sub-Saharan Africa. Proc. Conference Held at the International Livestock Center for Africa. 31 Aug. - 4 Sep., 1987. Addis Ababa, Ethiopia.

Tekalign M. and I. Haque. 1987. Phosphorus status of some Ethiopian Soils. Plant Soil 102 : 261-266.

## 9 aaV\_UZ

Table 1: Calculated N fertilizer requirement for soil nitrogen levels measured in total N

Total N (%)	N requirement		Total N (%)	N requirement	
	N (kg ha <sup>-1</sup> )	Urea (kg ha <sup>-1</sup> )		N (kg ha <sup>-1</sup> )	Urea (kg ha <sup>-1</sup> )
0	188.6	410.0	0.3	86.7	188.5
0.01	185.2	402.6	0.31	83.3	181.1
0.02	181.8	395.3	0.32	79.9	173.7
0.03	178.4	387.9	0.33	76.5	166.3
0.04	175.0	380.5	0.34	73.1	158.9
0.05	171.6	373.1	0.35	69.7	151.6
0.06	168.2	365.7	0.36	66.3	144.2
0.07	164.8	358.3	0.37	62.9	136.8
0.08	161.4	350.9	0.38	59.5	129.4
0.09	158.0	343.6	0.39	56.1	122.0
0.1	154.6	336.2	0.4	52.7	114.6
0.11	151.2	328.8	0.41	49.3	107.2
0.12	147.8	321.4	0.42	45.9	99.9
0.13	144.4	314.0	0.43	42.5	92.5
0.14	141.1	306.6	0.44	39.1	85.1
0.15	137.7	306.6	0.45	35.7	77.7
0.16	134.3	291.9	0.46	32.3	70.3
0.17	130.9	284.5	0.47	29.0	62.9
0.18	127.5	277.1	0.48	25.6	55.6
0.19	124.1	269.7	0.49	22.2	48.2
0.2	120.7	262.3	0.51	15.4	33.4
0.21	117.3	254.9	0.52	12.0	26.0
0.22	113.9	247.6	0.53	8.6	18.6
0.23	110.5	240.2	0.54	5.2	11.2
0.24	107.1	232.8	0.55	1.8	3.9
0.25	103.7	225.4	0.553	0.0	0.0
0.26	100.3	218.0			
0.27	96.9	210.6			
0.28	93.5	203.2			
0.29	90.1	195.9			

Table 2: Calculated N fertilizer requirement for soil nitrogen levels measured in organic matter

Organic matter (%)	N requirement		Organic matter (%)	N requirement	
	N (kg ha <sup>-1</sup> )	Urea (kg ha <sup>-1</sup> )		N (kg ha <sup>-1</sup> )	Urea (kg ha <sup>-1</sup> )
0	190.4	413.9	5	85.8	186.4
0.1	188.3	409.3	5.1	83.7	181.9
0.2	186.2	404.8	5.2	81.6	177.3
0.3	184.1	400.2	5.3	79.5	172.8
0.4	182.0	395.7	5.4	77.4	168.2
0.5	179.9	391.1	5.5	75.3	163.7
0.6	177.8	386.6	5.6	73.2	159.1
0.7	175.7	382.0	5.7	71.1	154.6
0.8	173.6	377.5	5.8	69.0	150.1

4	106.7	231.9	9	2.1	4.5
4.1	104.6	227.4	9.1	0.0	0.0
4.2	102.5	222.8			
4.3	100.4	218.3			
4.4	98.3	213.7			
4.6	94.1	209.2			
4.7	92.0	204.6			
4.8	89.9	200.1			
4.9	87.9	195.5			

Table 3: Calculated P fertilizer requirement for soil P levels measured by Bray-II method

Bray-II P (mg kg <sup>-1</sup> )	P requirement		Bray-II P (mg kg <sup>-1</sup> )	P requirement	
	P <sub>2</sub> O <sub>5</sub> (kg ha <sup>-1</sup> )	DAP (kg ha <sup>-1</sup> )		P <sub>2</sub> O <sub>5</sub> (kg ha <sup>-1</sup> )	DAP(kg ha <sup>-1</sup> )
0	225.2	489.5	5	147.8	321.4
0.1	223.6	486.1	5.1	146.3	318.0
0.2	222.1	482.7	5.2	144.7	314.6
0.3	220.5	479.4	5.3	143.2	311.3
0.4	219.0	476.0	5.4	141.6	307.9
0.5	217.4	472.6	5.5	140.1	304.5
0.6	215.9	469.3	5.6	138.5	301.2
0.7	214.3	465.9	5.7	137.0	297.8
0.8	212.8	462.6	5.8	135.5	294.5
0.9	211.2	459.2	5.9	133.9	291.1
1	209.7	455.8	6	132.4	287.7
1.1	208.1	452.5	6.1	130.8	284.4
1.2	206.6	449.1	6.2	129.3	281.0
1.3	205.0	445.7	6.3	127.7	277.6

4.1	161.7	351.6	9.1	84.4	183.5
4.2	160.2	348.2	9.2	82.9	180.2
4.3	158.6	344.9	9.3	81.3	176.8
4.4	157.1	341.5	9.4	79.8	173.4
4.5	155.6	338.2	9.5	78.2	170.1
4.6	154.0	334.8	9.6	76.7	166.7
4.7	152.5	331.4	9.7	75.1	163.3
4.8	150.9	328.1	9.8	73.6	160.0
4.9	149.4	324.7	9.9	72.0	156.6

Table 3 (contd.) Calculated P fertilizer requirement for soil P levels measured by Bray-II method

Bray-II P (mg kg <sup>-1</sup> )	P requirement		Bray-II P (mg kg <sup>-1</sup> )	P requirement	
	P <sub>2</sub> O <sub>5</sub> (kg ha <sup>-1</sup> )	DAP (kg ha <sup>-1</sup> )		P <sub>2</sub> O <sub>5</sub> (kg ha <sup>-1</sup> )	DAP(kg ha <sup>-1</sup> )
10	70.5	153.3	13	24.1	52.4
10.1	69.0	149.9	13.1	22.6	49.0
10.2	67.4	146.5	13.2	21.0	45.7
10.3	65.9	143.2	13.3	19.5	42.3
10.4	64.3	139.8	13.4	17.9	38.9
10.5	62.8	136.4	13.5	16.4	35.6
10.6	61.2	133.1	13.6	14.8	32.2
10.7	59.7	129.7	13.7	13.3	28.9
10.8	58.1	126.4	13.8	11.7	25.5
10.9	56.6	123.0	13.9	10.2	22.1
11	55.0	119.6	14.0	8.8	19.1
11.1	53.5	116.3	14.1	7.1	15.4
11.2	51.9	112.9	14.2	5.5	12.1
11.3	50.4	109.5	14.3	4.0	8.7
11.4	48.8	106.2	14.4	2.5	5.3
11.5	47.3	102.8	14.5	0.9	2.0
11.6	45.8	99.5	14.6	0.0	0.0
11.7	44.2	96.1			
11.8	42.7	92.7			
11.9	41.1	89.4			
12	39.6	86.0			
12.1	38.0	82.7			
12.2	36.5	79.3			
12.3	34.9	75.9			
12.4	33.4	72.6			
12.5	31.8	69.2			
12.6	30.3	65.8			
12.7	28.7	62.5			
12.8	27.2	59.1			
12.9	25.6	55.8			

Table 4: Calculated P fertilizer requirement for soil P levels measured by Olsen method

Olsen P (mg kg <sup>-1</sup> )	P requirement		Olsen P (mg kg <sup>-1</sup> )	P requirement	
	P <sub>2</sub> O <sub>5</sub> (kg ha <sup>-1</sup> )	DAP (kg ha <sup>-1</sup> )		P <sub>2</sub> O <sub>5</sub> (kg ha <sup>-1</sup> )	DAP(kg ha <sup>-1</sup> )
0	225.2	489.5	5	127.9	278.0
0.1	223.2	485.2	5.1	125.9	273.8
0.2	221.3	481.0	5.2	124.0	269.5
0.3	219.3	476.8	5.3	122.0	265.3
0.4	217.4	472.5	5.4	120.1	261.1
0.5	215.4	468.3	5.5	118.2	256.9
0.6	213.5	464.1	5.6	116.2	252.6
0.7	211.5	459.8	5.7	114.3	248.4
0.8	209.6	455.6	5.8	112.3	244.2
0.9	207.6	451.4	5.9	110.4	239.9
1	205.7	447.2	6	108.4	235.7
1.1	203.7	442.9	6.1	106.5	231.5
1.2	201.8	438.7	6.2	104.5	227.2
1.3	199.9	434.5	6.3	102.6	223.0
1.4	197.9	430.2	6.4	100.6	218.8
1.5	196.0	426.0	6.4	100.6	218.8
1.6	194.0	421.8	6.6	96.8	210.3
1.7	192.1	417.6	6.7	94.8	206.1
1.8	190.1	413.3	6.8	92.9	201.9
1.9	188.2	409.1	6.9	90.9	197.6
2	186.2	404.9	7	89.0	193.4
2.1	184.3	400.6	7.1	87.0	189.2
2.2	182.3	396.4	7.2	85.1	185.0
2.3	180.4	392.2	7.3	83.1	180.7
2.4	178.5	388.0	7.4	81.2	176.5
2.5	176.5	383.7	7.5	79.2	172.3
2.6	174.6	379.5	7.6	77.3	168.0
2.7	172.6	375.3	7.7	75.4	163.8
2.8	170.7	371.0	7.8	73.4	159.6
2.9	168.7	366.8	7.9	71.5	155.4
3	166.8	362.6	8	69.5	151.1
3.1	164.8	358.3	8.1	67.6	146.9
3.2	162.9	354.1	8.2	65.6	142.7
3.3	161.0	349.9	8.3	63.7	138.4
3.4	159.0	345.7	8.4	61.7	134.2
3.5	157.1	341.4	8.5	59.8	130.0
3.6	155.1	337.2	8.6	57.8	125.7
3.7	153.2	333.0	8.7	55.9	121.5
3.8	151.2	328.7	8.8	54.0	117.3
3.9	149.3	324.5	8.9	52.0	113.1
4	147.3	320.3	9	50.1	108.8

4.1	145.4	316.1	9.1	48.1	104.6
4.2	143.4	311.8	9.2	46.2	100.4
4.3	141.5	307.6	9.3	44.2	96.1
4.4	139.6	303.4	9.4	42.3	91.9
4.5	137.6	299.1	9.5	40.3	87.7
4.6	135.7	294.9	9.6	38.4	83.5
4.7	133.7	290.7	9.7	36.4	79.2
4.8	131.8	286.5	9.8	34.5	75.0
4.9	129.8	282.2	9.9	32.6	70.8

Table 4(contd.): Calculated P fertilizer requirement for soil P levels measured by Olsen method

Olsen P (mg kg <sup>-1</sup> )	N requirement		Olsen P (mg kg <sup>-1</sup> )	N requirement	
	P <sub>2</sub> O <sub>5</sub> (kg ha <sup>-1</sup> )	DAP (kg ha <sup>-1</sup> )		P <sub>2</sub> O <sub>5</sub> (kg ha <sup>-1</sup> )	DAP(kg ha <sup>-1</sup> )
10	30.6	66.5	11	11.2	24.2
10.1	28.7	62.3	11.1	9.2	20.0
10.2	26.7	58.1	11.2	7.3	15.8
10.3	24.8	53.9	11.3	5.3	11.6
10.4	22.8	49.6	11.4	3.4	7.3
10.5	20.9	45.4	11.5	1.4	3.1
10.6	18.9	41.2	11.6	0.0	0.0
10.7	17.0	36.9			
10.8	15.0	32.7			
10.9	13.1	28.5			



## J` Z\_R\_UMReVc ; ` \_dVcgReZ \_

Hf R\_eZjZ\_XeYVA^ aRIed` VCZVde T KcR^ a|Z\_X` \_ I f` \_WJ` Z`C` dHR\_U; c` a  
OZjUf` \_UVc KcRUZZ` \_Rj KVVW f |eZgReZ` \_ Jj deV^

Tadele Amare<sup>1</sup>, Gete Zeleke<sup>2</sup>, Tesfaye Feyisa<sup>1</sup> Minilk Getaneh<sup>1</sup>, Bitew Genet<sup>1</sup> and  
Yihenew G.Selassie<sup>1</sup>

<sup>1</sup> Adet agricultural Research center, P. box , 08, Bahir Dar,

<sup>2</sup> World Food Program, Addis Ababa, Ethiopia.

### 9 Sdecrle

Tef is one of Ethiopian stable food crops and is widely cultivated in many areas of the country. It needs fine seed bed preparations and is planted lately compared to other main season crops. Under the traditional farming system of tef, farmers use livestock trampling to compact the soil. There were two different hypotheses concerning the effects of trampling upon water and soil conservations. The first hypothesis was trampling reduces infiltration of water into the soil thereby increases runoff, soil loss, nutrient loss and finally grain yield would be reduced. The second hypothesis was in favor of trampling that trampling increases adhesion of soil particles thereby reduces soil loss and accompanying nutrient losses and hence increases yield. To justify the effects of trampling on run-off, soil loss and crop yield, a research was undertaken at Adet and Debre Tabor (on station) for four years with treatments trampled, leveled, and control. A runoff plot technique with a run-off and sediment trap at the bottom of each treatment was used for collection of water and soil loss. There was no significant difference between treatments for grain yield, plant height and root depth in general. However, there was very high significant difference between treatments for runoff and soil loss. The highest runoff (898.05m<sup>3</sup> water/ha) and soil loss (3549 kg /ha) was registered from trampled treatment while the lowest from the control (447.4 m<sup>3</sup>/ha water and 1518 kg soil /ha). Except the demand of livestock and other inputs for trampling, no reward or positive response was found from trampling; rather the loss of water and soil was very higher. The result generally showed that trampling is unjustified cultural practice.

Key words: farming system, infiltration and runoff, soil lose, Trampling,

### A ec` UF TeZ \_

The livelihood of Ethiopians and the country's gross domestic product mainly depend upon agriculture. Agriculture in Ethiopia is characterized by low mechanization, low chemical inputs (fertilizer, herbicides, insecticides) local crop varieties and local livestock breeds. In short, the country exercises extensive farming system. However, the carrying capacity of the land to support both livestock and crop is approaching reached to its maximum and extensive farming is always on the expense of natural resources (soil, forest and water). This is especially true in the highlands of Ethiopia where the number of livestock and human population is very high and land degradation reached to intolerable level (FAO, 1986). The effect of natural resources degradation was clearly observed on the occurrence of 1974 Ethiopia drought and famine (FAO, 1986). Degree of natural resource degradation varies within our country and the highest being in northern parts of the country where there are places that are rocked out and wasted. Amhara Regional State is one of the states seriously threatened by natural resources degradation (Lakew etal, 2000). Current degradation is more sever in the so called high potential areas for

agriculture in the region. There are different factors contributing for soil degradations in the region such as crop types and their cultural practices (sowing date, plowing frequency, crop cover etc). The region is dominated by annual crops that have positive relation with soil erosion (FAO, 1986, Lakew et al 2000). Among annual crops, tef is one of the major crops grown by farmers in the country as early as 1000 and 400 BC (Hailu and Seifu, 2000). Tef is a staple food for the country and different kinds of food staff are made of tef. According to CSA data of 1999, the area coverage of tef in Amhara region was 42.6 % from the total production area. Tef is planted very lately as compared to other cereal crops, needs fine seed bed preparation and trampling with livestock (Hailu and Seifu, 2000, Seifu, 1997). Because tef is planted very lately, the land is not covered during peak time of soil erosion and erosion from tef field is very high (FAO, 1986, Lakew et al., 2000). The importance of fine bed preparation for tef production is well justified by Hailu and Seifu (2000) and also by Sifu (1997). However making the bed too fine with frequent plowing is exposing the soil for erosion. As far as herbicides are used, there is no significant importance for plowing frequencies (Seifu, 1997) for tef production. Trampling is another cultural practice with tef production system. Trampling is exercised by farmers to promote germination and establishment, to make the seed bed firm, to prevent the soil surface from drying and to free the seed bed from weeds (Seifu, 1997). He also added that in areas with sufficient rainfall, trampling is not needed for promoting germination and establishment. But others argue that trampling has a negative impact on water infiltrations and hence moisture conservation (Connolly et al., 1998, G. Tadesse et al., 2002, G. Fierer and J. Gabet, 2002, and Van vuren et al, 2001). They all justified that trampling reduces infiltration by closing the porous system and therefore increases runoff. Increasing runoff is reducing the moisture of the soil and runoff is accompanied with soil loss. Moreover, the need to livestock for trampling makes the practice more costly from both individual farmers and community levels perspective. Regardless of all the arguments listed, there is limitation of research results showing full-fledged data on the effect of trampling on grain yield, runoff, soil loss etc. Therefore, data based information generation remains vital to reach into conclusions either to accept or reject trampling. The research was, therefore, carried out with the objective of investigating and quantifying impacts of livestock trampling on runoff, soil loss, yield and weed infestation.

#### **D ReVcZj R UD VëY Ud**

The experiment was carried out at Adet and Debre Tabor (on stations) for four consecutive years. Sites were representative for major soils and slope ranges to each location. Plowing frequency, fertilizer rate, seed rate, time of planting and trampling were according to farmers practice. Plots with 5 meter by 22 meters were used. Treatments were: 1) leveled 2) control 3) trampled. Each treatment was randomized and replicated three times. So as to avoid treatment mixing and entering of run off from out side of the testing plot, each plot was surrounded by corrugated iron sheet. Runoff plot technique was employed to assess soil and water loses. At the bottom of each plot, there was a runoff collecting tanker. Data was collected whenever there was rainfall. Amount of water was measured with volumetric cylinder. From collected runoff, one liter uniformly mixed sample was taken and filtered with filter paper. The sample was oven dried and dry weight of soil sample was measured and the total weight from the runoff was calculated.

Weed infestations from each plot was uprooted and the fresh weight was measured. All agronomic data including grain yield, plant height and root length were taken. Finally, the data were analyzed using MSTATC statistical software to test the hypothesis.

### 1.2.1. Effect of trampling on agronomic parameters of tef and weed bio-mass

As could be seen in Table 1, for most of the parameters considered there was no significant difference among treatments. At very early stage of the crop stand, the trampled and leveled plots looked visually better and uniform than the control. However, at the end of its course of growing, almost all treatments become uniform. It is in agreement with conclusions of Seifu (1997) that for places with enough moisture, response of tef yield for trampling is low. There was a slight increase in yield for trampling for some of the years but it was not statistically significant.

Table 1: Effect of trampling on grain yield selected agronomic parameters of tef and weed bio-mass

Treatment	YEAR- 1				
	Average Stem diameter (mm)	Average plant height (cm)	Average max. root depth. (cm)	Fresh weed weight (kg/plot)	Average grain yield (kg/ha)
Level	1.677	81.240	63.767	15.767	1407.590
Non-trampled	1.550	83.0800	63.100	13.317	1427.590
Trampled	1.667	82.567	63.067	8.367	1588.501
F- value	0.3101	0.1196	0.1451	11.0090	13.8132
Prob.	0.3101	NS	NS	0.0236*	0.0160*
C.V.	13.43	7.77	2.84	15.76	3.13
	YEAR 2				
Level	1.920	87.533	83.433	80.967	1518.197
Non- trampled	1.860	89.467	79.100	84.233	1384.862
Trampled	1.743	90.157	78.200	33.000	1612.137
F- value	4.8802	0.1297	2.5028	12.3466	1.0338
Prob.	0.0845	0.1297	0.1973	0.0194*	0.4346
C.V.	3.83	7.34	3.82	21.40	12.93
	YEAR 3				
Level	1.820	85.957	62.300	65.200	1092.435
Non- trampled	1.823	84.523	66.333	75.467	939.100
Trampled	1.657	84.137	69.733	47.300	1120.920
F- value	2.2292	0.4547	1.9891	4.3605	1.2624
Prob.	0.2236	NS	0.2514	0.0989	0.3758
C.V.	6.26	2.90	6.91	18.87	14.35
	YEAR 4				
Level	1.833	103.267	65.333	65.667	1485.151
Non-trampled	1.777	106.600	63.333	75.633	1434.242
Trampled	1.683	101.667	66.333	33.633	1484.545
F- value	1.0661	0.7296	0.2414	3.7387	1.14
Prob.	0.4255	NS	NS	0.1215	0.4043
C.V.	7.20	4.91	8.28	33.1	3.22

### 3.2.2.1.1. Results

There was highly significant difference between treatments for both runoff and soil loss (Table 2). The highest amount of runoff and soil loss was recorded from trampled plots. This result disagrees with the hypothesis that trampling is good in moisture stress areas to maintain soil moisture and thereby increase grain yield (Seifu, 1997).

Table 2: the effect of land preparation techniques on runoff and soil loss

Treatment	Total soil loss (kg/ha)	Total runoff (m <sup>3</sup> /ha)
Level	1968	431.072
Not trampled	1518	447.399
Trampled	3549	898.049
F- value	10.8733	25.6506
Prob.	0.0010	0.0000
c.v.	47.77	30.61

Similar to the results of this research, Connolly et al. (1998) also found that grazing of animals reduced the infiltration because of trampling and vegetation reduction. Taddese et al. (2002) evaluated the impact of trampling on the physical characteristics of Vertisols in Ethiopia and reached into conclusion that from plots of heavy grazing fields, the soil was resistant for water penetration. This resistance was due land compaction by animals that created high runoff which was in agreement with findings in this experiment. The research result of this experiment agrees with the findings of Fierer and Gabet (2002) and Van Vuren et al. (2001).

### 3.2.2.1.2. Conclusions

From the results of the experiment, it is possible to make the following conclusions.

- Trampling had lesser contribution in reducing weed infestation;
- Trampling didn't have positive contribution for grain yield;
- The soil loss from the trampled treatment was more than the non-trampled treatment by two folds. Therefore, trampling enhances soil loss;
- Trampling reduces infiltration and thereby increases runoff.

From the results of the experiment, it is possible to recommend that farmers can grow tef with out trampling their fields. This practice will reduce run-off, soil loss and increases profitability of tef production.

### 3.2.2.2. References

- Central Statistical Authority. 1999. Agricultural sample survey 1998/99 volume I: Report on area and production for major crops (private peasant holdings, meher season). Statistical Bulletin 200, Addis Ababa.
- Connolly, R.D, Freebaim D.M, and Bell M.J. 1998. Change in soil infiltration associated with leys in south-eastern Queensland. Australian Journal of Soil research 36 (6):1057-1072
- FAO (Food and Agriculture Organization of the United Nation). 1986. Ethiopian Highland Reclamation Study. Final Report Volume 1. Report prepared for the

- Government of Ethiopia by the Food and Agriculture Organization of the United Nations
- Fierrer G., Noah and J.Gabet Emanuel. 2002. Carbon and nitrogen Losses by surface runoff following changes in vegetation. *Journal of Environmental Quality* , 31: 1207-1213
- Hailu Tefera and Seifu Ketema. 2000. Production and importance of tef in Ethiopian Agriculture. In Hailu Tefera, Getachew Belay and Mark Sorrels (ed.): *Narrowing the Rift Tef Research and Development*. Proceedings of the international workshop on Tef genetics and improvement, 16-19 October 2000, Addis Ababa, Ethiopia.
- Lakew Desta, Menale Kassie, Benin S. and Pender J. 2000. Land degradation and strategies for sustainable Development in the Ethiopian highlands: Amhara Region. *Socio-economics and policy research Working Paper 32*. ILRI (International livestock Research Institute), Nairobi, Kenya.122pp.
- Seifu Ketema. 1997. Tef. *Eragrostis* (Zucc.) Trotter. Promoting the conservation and use of underutilized and neglected crops .12. Institute of plant genetics and crop plant research , gaterra/ International plant genetics resources institute , Rome, Italy.
- Taddese G., Mohamed Saleem, M.A and W. Ayalneh. 2002.Effect of livestock grazing o n physical properties of a cracking and self mulching vertisol. *Australian Journal of Experimental Agriculture* 42(2) 129-133
- Van Vuren, Dirk H, L.Johnson, Michael and Bowen Lizabeth. 2001. Impact of Feral Livestock on Island Watersheds. *Journal of Pacific Science* 55(3) 285-289

## 9 Abstract of the MSc Degree

Agnew et al.; Yirga Alemsefer, Gizaw Desta<sup>1</sup>, Yonas Girma<sup>1</sup>, and Gete Zeleke<sup>2</sup>

<sup>1</sup>Debre Birhan Agricultural Research Center  
P.O.Box 112, Debre Birhan

<sup>2</sup>Amhara Regional Agricultural Research Institute (ARARI), P.O.Box 527,  
Bahir Dar

### 9.1 Introduction

Formal survey was conducted in north shewa zone to investigate the extent, potentials, and management of wetlands there by characterizing them for proper utilization and management. The weredas covered by this study were Angolela Tera, Ansokiya Gemza, Basona Werana, Asagirt, Efratana Gidim, Ensarona Wayu, Gerakeya, Hagremariam, Kewet, Lalomama, Merhabete, Mida Weromo, Mojana Wedera and Tarmaber. Wetlands are areas of marsh, fen (deep marshes), peat lands or waters (containing decomposed and partly decomposed organic matter), whether natural or artificial, permanent or temporary, with water static or flowing, fresh, brackish or salty, including areas of marine water with the depth of which at low tide does not exceed six meters. Most of these landforms in this zone were temporary wetlands usually used as grazing areas and crop and tree production when dry; and animal watering when wet. More than 2000 hectares of wetlands have been identified during the survey. However, the coverage was estimated to be about 10510 ha from topographic maps with 1:50000 scale. The current purposes of the surveyed wetlands by percent of responses was for grazing (31.82%), animal drinking (15.15%), source of drinking water for human being (9.09%), hay source (13.64%), vegetable production (16.67%), and tree plantation and nursery (10.61%). The wetlands are underutilized and threatened due to unsafe grazing, ground water exploitation, pollution, sedimentation, and inappropriate cultivation. There was very little awareness by the farmers as to the intensive utilization of wetlands and proper management practices. As a result, some flora (such as Fila, Dodot, Mush, Ablalit, Amkiela and Shenet) and fauna (such as Shurubit, Yewuhaenat and frog) have been extinct from some wetlands.

Few numbers of wetlands were covered by the formal survey and a wider range of research remains on the investigation and identification of potential management and effective utilization alternatives of each resource particularly to those wetlands which have large coverage and potentials. Wetlands found in Angolela Tera, Ensarona Wayu and Antsokia Gemza should be given special consideration for their potential utilization. Community education and formulation of bylaws for the protection, utilization, and management of wetlands are immediate actions to be taken.

Key words: biodiversity, North Shewa, proper management and utilization, Wetland

### 9.2 Discussion

Wetlands and water bodies are key resources for rural areas to fall back during extended dry seasons. However, these resources are under pressure due to severe degradation in the up stream catchments and the subsequent heavy load of sediment and solute transport into the system. As a result, quality of water (usually used by rural households) and other fauna and flora (last reserves) could be threatened. On the other hand, with the increasing population pressure and diminishing land size, inappropriate use of these resources is obvious. This demands special attentions to these resources.

According to the Ramsar Convention 1971, wetlands are defined as "Areas of marsh, fen, peat lands or water whether natural or artificial, permanent or temporary with static or flowing, fresh, brackish or salt, concluding areas of marine water the depth of which at low tide does not exceed six meters" (Stuip et al. 2002). This definition is obviously very broad and includes even lakes and rivers. According to humanity development library wetlands are unique transient ecosystems,

falling between true aquatic systems on one hand and terrestrial systems on the other. The water table is usually at or near surface, or the land is covered by shallow water.

Wetlands have essential functions, uses, and values to the people in the area. First, it serves for income generation by selling plant and animal sources, by production of crops and raising animals through improved management. Second, it serves for biodiversity conservation through protection that creates sustainable eco-system and tourism in the area. Third, it helps to arrest floods, recharge ground water, improve water qualities, deposit transported sediments and nutrients, and have a vital role in the hydrologic cycle.

The coverage and distribution of wetlands is indicated on topographic maps. On the map it is indicated as swamps or marsh and areas subject to inundation. Using topographic maps, the coverage of wetlands is estimated to be 1.14 % of the land mass in Ethiopia (Leykun, 2003). It is also assumed 3.7 % of the total in Amhara region (Abye, 2001). However, as it was checked during the survey, all wetlands are not indicated on the map. This implies the coverage and distribution of wetlands is yet unknown in the region as well as in specific areas. It needs, therefore, verification at ground.

Wetlands are often situated in the valley bottoms where rivers emerged from uplands surrounded by mountains and plateaus are flooded. Formation of wetlands due to water logging is also commonly observed in the flat lands where Vertisols have extensive coverage.

Currently the utilization and management of wetlands vary from place to place. This happens due to the variation in population pressure, number of livestock population, the factors/conditions limiting crop production, and the extent of specific constraints of the community. Wetlands now are mainly utilized for pasture, vegetable production through irrigation, source of water for human and animal drinking, hay production, and tree planting and nursery. Because of the improper management and utilization, many of the wetlands show land slide and gulying due to livestock trampling when grazed during wet season, converted for cultivation, dried due to overexploitation of water sources, and silted up by sediments from untreated uplands. Eventually these processes lead to environmental impact which can not be easily measurable; it ranges from destabilized eco-system in the surrounding up to the drastic reduction of ground water as well as loss of biodiversity (flora and fauna). Subsequently, this will have environmental consequences and affect negatively the livelihood of the people depending on them. The study aimed at exploring the current utilization and management, potentials, and threats of wetlands in the study area. It also attempted to estimate the coverage of wetlands in the surveyed villages.

#### **D R E V E L O P M E N T U N D E R S T A N D I N G**

The surveyed woredas were selected based on their representativeness of the three (Dega, Weyna Dega, Kolla) agro-ecologies. About fourteen woredas were included in the survey. The survey has been conducted in Angolela Tera, Antsokia Gemza, Asagirt, Basona Worana, Efrata Gidim, Ensaro Wayu, Gera Keya, Kewet, Hagere Mariam, Lalo Mama, Merhabete, Mida Weromo, Mojana Wedera, and Tarmaber. Since the definition of wetlands is very broad, which includes even rivers and lakes as far as their depth is less than 6 meters, in our study we tried to restrict the concept of the wetlands only to permanent or temporary marshy areas. The marshy areas usually have a water table at or near the earth surface or these lands covered temporarily by shallow water often during the rainy season.

Sites were selected through preliminary informal survey. Collection of primary data was done through formal survey. The survey was made in the form of focus group discussions and interviews with semi-structured questioners including transect walks. Detailed secondary data have been collected and reviewed which were available from different institutions. This used to verify the data provided by farmers. Primarily satellite images were intended to estimate the

coverage and distribution of wetlands. However, we were not able to get the images for this purpose. Instead, the area of each of the identified wetlands was simply estimated by asking the farmers in the surveyed villages and agriculture office experts. Topographic map at a scale of 1:50,000 have been used to estimate the area of the wetlands for comparison.

Data such as names, estimated area, current purpose and utilization, owner, future intention, threats, available and non-existence flora and fauna species, formation of wetlands, and rivers passing through and emerging from were collected. These data were subjected to descriptive statistics to explore the current overall attention given, utilization and risk management of wetlands.

### **1.3. Perception of the word wetland**

Perception of the word wetland is somewhat vague for the farmers and subject matter specialists. Traditionally the sense of the word in the surveyed woredas is marshy areas were a special grass known as filla grows. Lands affected by water logging during the main rainy season are also considered as wetlands. This perception is in the minds of the majority of the population.

Out of the 14 woredas surveyed, wetlands have been identified in 11 woredas. Most of the wetlands are located in the highlands where there is water logging problem of Vertisols. Wetlands situated in the lowlands are formed due to flooding of rivers. Most of these landforms in this zone are temporary wetlands usually used as grazing areas when dry. These lands are communally and privately owned with a share of 56.25 % and 43.75 %, respectively. Recently, the communal lands are distributed to individual households for grazing purpose. Private investors are showing interest on such lands for different purposes. For instance, in \_\_\_\_\_ woreda, wetland by the name \_\_\_\_\_ is leased out to an investor.

An estimated area of about 2027 ha of wetlands has been identified in the survey. The area of wetlands estimated by farmers and experts are highly underestimated when compared with the topographic map data. The coverage and distribution of wetlands were checked using 1:50 000 scale topo map. However, some of the wetlands identified in the survey are not indicated on the map and vice versa. The majority of the wetlands indicated on the map do not have similar names with the name provided by farmers and hence was difficult to verify its area. More likely, farmers considered and provided those wetlands which are utilized for individual households and for communal purpose in their villages. This might be the reason why many of the wetlands are small. The total coverage of wetlands indicated on the topo map is about 10510 ha without considering wetlands in Antsokia Gemeza and Hagre Mariam woredas. By considering wetlands around Kemissie the total area of wetlands is about 14872.50 ha. While the area estimated by farmers during the survey is about 2027 ha (Tables 1 and 2). This large discrepancy might be due to the estimation made by farmers. Even they did not estimate the area for some of the wetlands. Thus, the extent as well as distribution of wetlands indicated on the map need to be further verified using an image data. Moreover, recently extensive coverage of land is abandoned due to water logging, sedimentation and to some extent salinity problems.



Table 1: An estimated area (ha) of wetlands found in each wereda

M` cUR	? `e MYVv KYV MVJR_UAd>` f_U	ER^ V` Vh VjR_U	=dZ` ReWU 9 cVR YR	9 cVR W ^ e a` ^ Ra( YR)
Angolela Tera	Asa Bahir	Fwafwatie	30.00	407.5
	Asa Bahir	Enchuni dodoti/Kacha cola wenz	60.00	
	Boren	Kes meret	24.00	
	Chefanen	Jelisa/sanka	22.00	
	Cheki	Dodotina abadira	100.00	
	Gendewera	Derie meda	20.00	
	Safii	Islam mekaber	10.00	
	Totosie	Sanka	375.00	1502.5
Antsokia Gemza	Bulelie and Selama	Mekedesa cheffa	300.00	
	Atko	Atko Cheffa	300.00	
	Harbu Welde	Harbu Welde	300.00	
	Fiecho	Fiecho	50.00	
	Chekechek	Chekechek	20.00	
	Getem	Getem	50.00	
Basona Werana	Abamotie	Legevida (Workie)	30.00	147.5
	Aloberet	Aloberet	30.00	420.00
	Berie Ager	Dibunu	-	
	Berie Ager	Arsi amba	-	40
	Debele	Abisa ager	-	
	Debele	Tora mesk	120.00	135
	Faji	Milki	-	
	Faji	Tach faji	-	
	Genet	Genet	-	
Efratana Gidim	Alala	Alala	-	165
	Hora Chefie	Hora chefie	50-60.00	
	Gadilo-mehal wenz	Gadilo	2.00	
	Kori Meda	Kori Meda	5.00	
	Kechen Meda-Selelona	Kechen Meda	1.00	
	Negieso-Jewuha	Negieso	3.00	65
	Metkoriva-Ambober	Metkoriva	1.00	
Ensaronu Wayu Gera Keya	Agemso	Fincha	0.05	
	Angergera	Jer	1.00	
	Armongheorgis	Abaramesk	4.00	
	Bevu	Wulcho	0.05	
	Bodanakurie	Bera	1.00	
	Delie Amba	Keitiema	0.50	
	Kembo	Cheffa mesk	0.75	
	Gracha	Abavrobana cheffa	1.00	
	Kechinmesk	Kechinmesk	0.03	
	Ken	Lehumesk	1.00	
	Lavignaw Kevet	Bera	0.75	
	Mesko	Shemanie wenz	0.50	
	Oeig	Seka mesk	1.50	
	Robie Wenz	Robie wenz	0.85	
	Romiena Sakela	Deriena wabe chetu dalina	0.50	632.5
	Salavish	Shinkurtwoha /cheffa/	1.00	
	Seliela	Shele	0.25	25
	Sorni	Sorni	0.75	
	Wezed	Wezed	3.00	
	Mesel Mariam	Mesel Mariam	10.00	
	Gragn	Gragn	3.00	
	Furkuta	Furkuta	3.00	
	Alo Bahir	Alo Bahir	4.00	60
Gumer	Gumer	3.00		
Negasi Amba	Negasi Amba	3.00		
Gedi	Gedi	3.00		
Hagre Mariam- Kesem	Enjorer	Enjorer	1.00	
	Abodansie	Araba	0.83	
	Shola Agebe	Shola Gebeva	0.03	
	Gebrial Agebe	Yelchet	0.01	
	Kidus Ge/washa	Kesem	1.00	
	Tach Sechat	Dindit	0.13	
Zolazenbaba	Anbo	0.03		

Table 1: (Contd.)

M <sup>c</sup> UR	? <sup>e</sup> MY <sup>e</sup> V KYV MV <sup>e</sup> R_UA <sup>i</sup> > f_U	ER <sup>A</sup> V <sup>h</sup> Vh <sup>e</sup> R_U	=dZ <sup>h</sup> ReWU 9 cVR YR	9 cVR W <sup>^</sup> e a <sup>^</sup> Ra(YR)
Kewet	Agam Ber/	Angav Tsebel	6.00	
	Agam Ber/ Charie	Felwuha	4.00	
	Yelen	Hora	5.00	
	Yelen Wacho	Tikur wuha	3.00	
	Zuti	Prison	5.00	
Lalo Mama	Astova	Astova	0.125	30
	Ago	Sewaro	0.25	
	Gurmign	Koso	0.25	12.5
	Kebele 06 Dasa	Yecha gons	0.15	
	Kebele 07	Angewa	15.00	
	Kebele 10	Agwat wuha	-	
	Kebele 10	Wemso	>0.50	
	Kebele 14/Tarma	Shema matebiva	8.00	
	Kebele 18/Tama Wenz	Menchcheffit	-	
	Kebele 20	1.kevet got/wevra meder	0.0652	
	Kebele 20	2. Afkera	-	
	Kebele 22	TirTra	0.0600	
	Kebele 25 Shavisho	Dot	-	
Tarmaber	Armania	Armania	1.00	
	Gorji	Around nursery site	20.00	
	Wanza Beret	Road side	4.00	
Merhabetic	Tembeito	Bira	1.00	
	Makur kola	Bira	1.00	
Total Estimated Area of wetlands surveyed			2027.91	

Currently farmers utilize the wetlands for grazing (31.82 %), vegetable and crop production during dry and belg season (16.67 %), animal drinking (15.15 %), hay source (13.64 %), tree plantation and nursery (10.61 %), and source of drinking water for human being (9.09 %). In addition wetlands are sources of biodiversity like different grass species used for roof thatching, and income sources for the poor farmers. As it was mentioned, wetlands are mainly meant for grazing by which degradation and pollution has come into effect. The neighboring residents provide a very limited attention and protection. In some places, they do not even know what should be done to keep these ecosystems from extinction. Farmers' opinion whether or not risky management practices were being undertaken by the nearby residents was collected. Farmers responded 65.5 % none, 20.7 % of tree planting that reduce the previous condition and coverage of wetlands, 10.3 % rising demand of cultivation land, and 3.5 % sedimentation. However, it is observed that compaction, land slide and gully formation due to excessive cattle grazing in the rainy season in water logged areas are of serious concern. Sedimentation due to excessive soil erosion and opencast mining, over-exploitation of ground water, cultivation for tree plantation, and minor pollution are mainly the factors that threaten wetlands in the study area. Under the current utilization, the ecosystem is highly affected because of unsustainable management of the system. Though there are such poor management practices, farmers and experts do not realize the negative impacts of these activities on the overall ecosystem.

Table 2: Area and location coordinates of wetlands indicated on the topographic map

Wetland Name	Location	District	Area (ha)	Total Area (ha)	Coordinates			
					East	North	East	North
Asa Bahir	Angolelana Tera	0939D1	16.30	407.50	104000	104700	555000	559000
Tengego+Seriti+	Angolelana Tera	0939A4	153.00	3825.0	9°30'	105900	542000	554000
Aloberet	Basona Werana	0939A4	16.80	420.00	106200	106700	547000	551000
Arsi Amba or	Basona Worana	0939B3	1.60	40.00	106500	106700	572000	574000
Debele &	Basona Worana	0939B3	5.40	135.00	106100	106400	571000	575000
Dinbaro +Bakelo	Basona Worana	0939B3	19.30	482.50	107000	107600	566000	572000
Worke	Basona Worana	0939B1	5.90	147.50	9°45'	108000	567000	572000
Alela and Menter	Efratana Gidem	1039B3	6.60	165.00	113700	114000	601000	607000
Birtulom	Efratana Gidem	1039B3	2.70	67.50	114100	114400	600000	603000
Golecha Amba +	Efratana Gidem	1039B3	3.20	80.00	113400	113700	599000	602000
Jewuha	Efratana Gidem	1039D4	2.60	65.00	111600	111800	604000	607000
Hora swamp	Efratana Gidem	1039D4	3.00	75.00	114600	114700	601000	602000
Dire Gebre Korki	Ensarona Wayu	0939A3	7.50	187.50	107600	9°45'	511000	514000
Menehoro/Rikich	Ensarona Wayu	0939A3	42.00	1050.0	106900	107300	515000	522000
Sakila	Ensarona Wayu	0939A3	18.60	465.00	107300	9°45'	524000	39°15'
Sakila	Ensarona Wayu	0939A1	17.80	445.00	9°45'	108300	523000	526000
Selela	Ensarona Wayu	0939A3	1.00	25.00	107500	107700	517000	518000
Tosny/Jelbe	Ensarona Wayu	0939A3	33.80	845.00	106500	107200	506000	513000
Wele Deneba	Ensarona Wayu	0939A1	15.50	387.50	9°45'	108400	512000	522000
Weryo+Salayish	Ensarona Wayu	0939A4	31.30	782.50	106900	9°45'	535000	541000
Alo Bahir	Gera Keya	1039C4	2.40	60.00	112900	113100	552000	553000
Bish/Borken+Let	Kemissie	1039B4	70.20	1755.0	117000	117900	592000	602000
Borkena+Bish	Kemissie	1039B4	32.00	800.00	117600	118400	587000	597000
Chireti	Kemissie	1039B4	23.60	590.00	116400	116900	596000	602000
Kortem + Multu	Kemissie	1039B4	48.70	1217.5	117900	10°45'	588000	598000
Istoya	Lalo Mama	1039D3	1.20	30.00	111000	111200	568000	570000
Koso	Lalo Mama	1039D3	0.50	12.50	112100	112300	572000	574000
Afezez(Jema)	Merhabetie	0939A1	6.50	162.50	109900	110200	500000	505000
Dawo+Menalafto	Moretena Jiru	0939A1	8.90	222.50	108400	108700	522000	39°15'
<b>Total</b>				<b>1043. *</b>				

Farmers tried to mention the untapped benefits or future potential uses of the wetlands. Accordingly, it will have potential for vegetable irrigation production (29 %), for any development program (12.9 %), for drinking (9.68 %), and note identified (48.39 %). Major fauna of wetlands were frog ( ), birds (including Gagano), and fish ( ). It was found out that some species of fauna like frog, and have been lost from some wetlands. Like wise the major flora of the wetlands in North Shewa are Eucalyptus, grass species ( ), leafy species such as . There were also some species of flora that

have extinct from some wetlands. This species were

; ` \_Tlf dZ\_ R UcVT ^ ^ V\_URz\_

A few numbers of wetlands were covered by the formal survey. It is attempted to observe the extent, current utilization, and management of wetlands from the sample wetlands to bring attention on it. Wetlands are meant for different purposes beyond its environmental benefit. They are also sources of plant and animal species which are useful for the ecosystem. The low awareness of farmers about wetlands and the increasing threats are the limitations for potential utilization. Through proper management of wetlands there is a possibility to gain benefit by rearing livestock, producing vegetables and environmental benefit as a whole. Focus should be given on community education to increase their perception and knowledge so they can be able to choose and implement proper management options. Formulating bylaws to protect, utilize, and manage communal and private wetlands is another measure to be taken. A wider range of research remains on the investigation of effective utilization and potential management alternatives of each resource particularly to those wetlands which have large coverage and potential. This helps to identify the productive purposes that improve the livelihood of the surrounding farmers. Wetlands found in \_\_\_\_\_ and \_\_\_\_\_ should be given special consideration for further investigation to attain its potential utilization. Priority should also be given to map the extent and distribution of the wetlands using image data and verify the estimated coverage provided in this study as well as on the topo maps.

## I WwV Tm

- Abye Kindie. 2001. Wetlands Distribution in Amhara Region, their importance and current threats. Proceedings of the wetland awareness creation and activity identification workshop in Amhara National Regional State.
- Humanity Development Library. Biodiversity in the Western Ghats: An information kit
- Leykun Abunie. 2003. The distribution and status of Ethiopian wetlands. Proceedings of the seminar on the resources and status of Ethiopian wetlands, Yilma D. Abebe and Kim Geheb, IUCN .
- Stuip, M.A.M., Baker, C.J. and Oosterberg, W. 2002. The Socio-economics of Wetlands, Wetlands International and RIZA, The Netherlands.

**MYRE**

Gizaw Desta and Yonas Girma  
Debre Birhan Agricultural Research Center  
P.O. Box 112, Debre Birhan

## **9 Sdecrle**

An experiment on crop water requirements and irrigation scheduling was conducted at Bakelo irrigation area on Vertisol from 2001-2004. Soil water budget was used to determine the water requirements. Crop water requirement of wheat, barley, lentil, and potato were 392 mm, 356 mm, 284 mm and 448mm respectively. Out of which 236mm, 233 mm, 171 mm, 276 mm must be applied artificially and accounted as net irrigation requirements. Accordingly, the gross irrigation water required excluding pre-irrigation amounts will be 327mm, 250 mm 159 mm and 307mm for wheat, barley lentil, and potato correspondingly. As a result the number of irrigations for wheat, barley lentil and potato are four, two three and .six times during the growing season in that order. Among the tested irrigation frequencies for wheat, irrigation at early tillering + booting + milkstage, and at booting + milkstage have a better water distribution pattern over the season which in most of the periods coincided with the actual water balance in supplemental irrigation. The amount of water applied for irrigation regimes at early tillering, and booting independently was less than the net irrigation requirement of wheat.

An economical wheat yield benefit of 34 q/ha was obtained by applying water at early tillering (67mm) + booting (52mm) + milk stages (113mm). The marginal rate of return compared to the existing farmers' irrigation practice is 435 %. It is therefore recommended to apply water at early tillering + booting + milk stages of wheat in Bakelo irrigation area.

Keywords: growth stage based irrigation, optimum yield, water management

## **A ec` Uf TeZ\_**

Access to affordable irrigation has significantly reduced poverty because it addresses critical leverage points in the livelihood strategies of the rural poor by enhancing agricultural production and creating opportunities for more active and effective market participation. Improving the productivity of crops can be achieved by looking the economic productivity of water for maximum value using rainfall, surface water, and wastewater in the form of runoff.

Focus of most irrigation projects has been on large scale irrigation schemes. But there are quite a lot of small-scale irrigation holders (0.1-0.25 ha) which have not ever been documented. Even their productivity is not well known. They can be producing a great deal which we have to focus on. It is poor farmers that we move on to the end of poverty reduction. The research and development activities have also better to focus on small-holder irrigation instead of large scale infrastructures.

Rainfall amount during the season in the area is much lower than crop water requirements for economic production. Because of unfavorable rainfall pattern, soil moisture in the root zone often does not satisfy crop needs over the whole season. Since rainfall is the principal source of moisture for rain-fed crops, supplemental irrigation ( SI) is only applied when rainfall fails to provide essential moisture for improved and stabilized production. The amount and timing of SI are scheduled not to provide moisture stress-free conditions throughout the growing season, but to insure that there is a minimum amount of water available during the critical stages of crop growth that would permit optimal instead of maximum yield. Unlike full irrigation, the management of SI is dependent on the rainfall as a basic source of water for the crop.

The current irrigation method is by flooding the field or farm until water satisfied deep percolation, field capacity, or saturation level of the soil and depression storage of the clay soil. The farms irrigated in this way require a range of 7-10 days to dry the soil moisture to the level that crops need at planting – called ‘’ (farmers’ experience). The existing irrigation method (i.e. flooding) and allow free to use the limited water over the night for one field as they wish leads to water wastage and low performance in water use and obtaining optimal yield (Horst, 1998). Really this is the actual situation by which great losses of water is existing which needs immediate intervention on irrigation water scheduling. The most important considerations in good SI management are when and how much water to apply. Yet many, perhaps most, farmers apply too much water if they can get it. Evidence of the over- use of irrigation water is clear in many situations, and SI is no exception. Farmers tend to overuse water in supplemental irrigation because of the low water and irrigation costs they incur. The aim of irrigation scheduling should be to provide sufficient water to crops at the right time and also to discourage farmers from over irrigating.

One problem can be that the need for water occurs at the same time for all the planted area. Irrigation has to be applied to a large area in a short time. A large water supply rate and a large irrigation system are then needed. This conflicts with the limited water supply and the objective of minimizing the cost. To overcome this problem irrigation scheduling to specific water sensitive stages is proposed as one strategy.

Wheat sown at the beginning of the season is at early stages, and rate of root water extraction is low. This implies that little moisture stress occurs at this stage. However, plants grow faster with high rates of evapotranspiration and rapid soil moisture depletion. Thus, a stage of increasing moisture stress starts and continues until the end of the season. The most sensitive growth stages of wheat to water stress were from stem elongation to booting, followed by anthesis/flowering, and grain filling. The sensitivity index of wheat to water stress at individual growth stages were small in seedling stage, become larger from stem elongation to grain filling stage, and then become small after soft-dough stage (Zhang and Oweis, 1999). Water stress at stem elongation and ear formation increased tiller abortion significantly reduced ear number (Blum and Pnuel, 1990). The variation of sensitivity index during individual growth stages indicates that crop grain yield not only depends on the total water use during the growing season, but also on water use during individual growth stages (Zhang and Oweis, 1999). Water stress to which crop subjected depends on rainfall and its distribution during the growing season. Therefore, water stress during certain growth stages may have more effect on grain yield than similar stress at other growth stages.

Water use efficiency (WUE) is a measure of the productivity of the water consumed by the crop. In areas with limited water resources, where water is the greatest limitation to production, WUE is the main criterion for evaluating the performance of production systems. No longer is productivity per unit area the main objective, since land is not as limiting to production as is water (Oweis, 1997; Zhang and Oweis, 1999). The need for improving water-use efficiency in crop production and sustainable use of water resources are clearly urgent. Fully satisfying crop water requirements may be prohibitive in terms of sustainable utilization of limited water resources. The solution is to limit water application to specific stages, minimizing loss of yield from water stress. We need to know, therefore, at what stages of crop growth a small amount of water application results in optimal WUE and minimum reduction in yield.

## D ReVeZjdR\_U ^ VeY Ud

### Jef Uj dZVR\_U M aVcZ V\_ed

Supplemental irrigation experiments were carried out at Bakelo irrigation area (9.694 to 9.735 degree northing, 39.59 to 39.65 degree easting, and an altitude of 2820 to 3000m asl) from 2001 to 2004. The first year (2001) experiment was for determination of crop water requirement and monitoring of phenological stages of wheat, lentil, barley, and potato. From 2002 to 2003 an irrigation frequency experiment based on sensitive growth stages of wheat coupled with recommended fertilizer and with out fertilizer was conducted to determine the time of irrigation. In 2004 an experiment on 100 m<sup>2</sup> plot was conducted to verify the result obtained in the previous years. The study area, 15 km from Debre Brehan, has received the mean seasonal (February to June) rainfall and evaporation of 214 mm and 725 mm, respectively. The major soil type of irrigated farm lands is Vertisol ( ) with the associated water logging problem. The soil is characterized by heavy clay soil with water content at field capacity and wilting point (crop extractable water) of 49 % and 24 % by volume and bulk density of 1.19 gm/cm<sup>3</sup>. The area at which the study targeted is dependent on supplemental irrigation during and production seasons. The coverage of traditional irrigation production in Bakelo-Keyit small-scale irrigation area is estimated to be about 1100-1250 ha. The major water sources are River, D and streams (Sheno Survey Report, 2004). An estimated of 500-700 households is benefited from irrigation along the (personal communication). Among the crops grown under irrigation, wheat takes the largest proportion followed by lentil, faba bean and small proportions of fenugreek and barley. Farmers have also started to produce vegetables like garlic under irrigation.

### GYRIVAg; c` a MReVe I Vbf ZV^ V\_e

A preliminary study to generate data on crop phenology was conducted for wheat (S ), lentil ( ), barley ( ) and improved potato ( ). Water requirement for those crops was calculated using soil water budgeting based on the crop phenology and meteorological data (pan evaporation and rainfall) collected. Reference evapotranspiration (ET<sub>o</sub>) was computed using pan evaporation method (using 0.70 pan coefficient). Crop evapotranspiration was then calculated multiplying ET<sub>o</sub> by the crop coefficient values in the literature. Water requirement is defined as the quantity of water required by a crop in a given period for its normal growth under field conditions (Garg, 1989). The soil water depleted during the growing period was considered as irrigation requirement. Net irrigation requirement refers to the amount of water needed to replenish the soil water deficit in the crop field. Crop irrigation water requirement was determined for each required growth stages and for the whole growing period using the following mathematical relation.

$$KMI = \frac{AI_{ve} + I_{vw} + C}{\sum K_c a I_{vw}} = K_{re} a + C$$

Where,

- IRR<sub>net</sub> = Net irrigation requirement
- IRR<sub>gross</sub> = Gross irrigation requirement
- ET<sub>crop</sub> = Crop evapotranspiration/net crop water requirement
- RF<sub>eff</sub> = Effective rainfall
- TWR = Total water requirement
- Losses = Amount of water lost through deep percolation, application and distribution

Irrigation water amount at each stage was estimated to replenish soil water in the root zone to the field capacity when the available soil water dropped below a fraction of total available water (TAW). The fraction of TAW ( $p$ ) that a crop can extract from the root zone without suffering water stress is the readily available water (RAW). The quantity of RAW is commonly taken as  $p=0.50$  of the total available water (TAW) between field capacity (FC) and crop extractable water (CEW) for many crops (Figure 1).

$$K_9 M \text{ (mm)} = \theta_{fc} - \theta_{cew} \times a \times R_c$$

$$I_9 M \text{ (mm)} = K_9 M \times p$$

$$I_9 M = K_9 M \times (\theta_{fc} - \theta_{cew}) \times a \times R_c \times p$$

Where,  $\theta_{fc}$  is the water content at field capacity, %  
 $\theta_{cew}$  is the water content at crop extractable water, %  
 $R_c$  is the rooting depth, m  
 $a$  is depletion factor

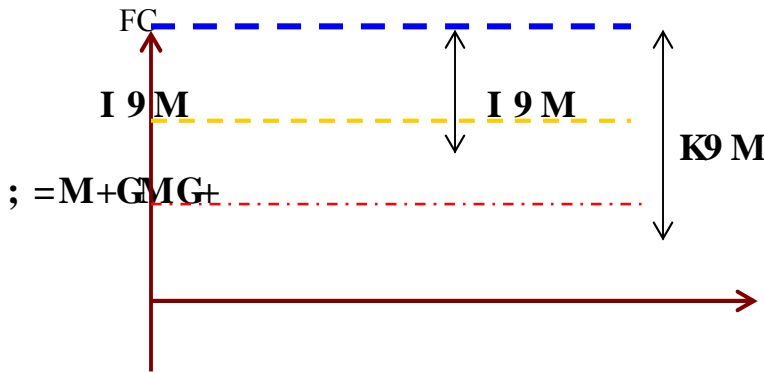

Fig. 1. Schematic illustration of available soil water in soil water budget

### When to irrigate

Phenological and crop water requirement information based on farmers planting practice without moisture stress condition for local wheat variety called were collected and determined in the first year experiment. Taking this information as a datum, an experiment on wheat irrigation frequency was conducted for two years. To evaluate watering frequency for wheat, split plot arrangement of five irrigation regimes with three replications was used. Main plot being fertilized (60\60 kg/ha N/P2O5) and unfertilized, and subplots being irrigation frequency at critical water requirement growth stages of local wheat,

#### Irrigation frequency periods

1.	Early tillering + booting + milk stage	(1	1	1)
2.	Early tillering	(1	0	0)
3.	Early tillering + milk stage	(1	0	1)
4.	Booting	(0	1	0)
5.	Booting + milk stage	(0	1	1)



Finally, in 2004 a trial was conducted using only the most promising irrigation frequency periods of wheat (or critical water requirement stages) identified in the previous experiment. Those irrigation frequency periods were:

- |    |  |      |
|----|--|------|
| a. | Early tillering + booting + milk stage<br>1 1) | (1   |
| b. | Early tillering + milk stage<br>1)             | (1 0 |
| c. | Booting + milk stage<br>1 1)                   | (0   |

#### ***How much water to irrigate***

In water-scarce areas, unlike in full irrigation, the amount of supplemental irrigation (SI) cannot be determined in advance. This is due to the fact that the basic source of water to rain-fed crops is rainfall, which being available in amount and distribution, is difficult to predict. Since SI water is best given when soil moisture drops to a critical level, the amount of irrigation applied at critical stages can be best determined by measuring soil moisture on regular basis. Different water levels were estimated at each growth stages based on the soil water budget using long-term average rainfall and evaporation records and soil water holding capacity. The irrigation water applied was estimated to replenish soil water in the root zone to the field capacity when the available soil water dropped below 50 % of total available water. The amount of total irrigation water applied at different critical stages was 75 % (T1, T3 and T5), 45 % (T4) and 31 % (T2) of the soil water amount required in the full supplemental irrigation condition.

#### **I Vof Jed R\_U < ZIf dZ \_**

#### **; c` a MRVc I Vbf ZV V\_e**

Taking sowing date during late January for belg production season the crop water requirement ( $ET_{crop}$ ) of wheat, barley, lentil and potato were found to be 392.08mm (3920.80 m<sup>3</sup>/ha), 355.95mm (3559.50 m<sup>3</sup>/ha), 283.65mm (2836.50 m<sup>3</sup>/ha), and 447.57mm (4475.70 m<sup>3</sup>/ha), respectively. Out of which 236.45mm (2364.50 m<sup>3</sup>/ha), 232.51mm (2325.10 m<sup>3</sup>/ha), 171.43mm (1714.30 m<sup>3</sup>/ha), and 276.18mm (2761.80 m<sup>3</sup>/ha) must be applied artificially and accounted as net irrigation requirements. The remaining amount of the net crop water requirement was supplied by rainfall. Therefore, the gross irrigation water should account for the losses due to percolation, and application and distribution inefficiencies probably field irrigation application inefficiency (flooding heavy clay soils) contributed a lot. Accordingly, the gross irrigation water required including pre-irrigation amounts to 377.16mm, 324.61mm, 208.88mm and 357.37mm for wheat, barley, lentil and potato, respectively. But excluding pre-irrigation the gross irrigation water requirement of wheat, barley, lentil and potato is 327.16mm, 249.61mm, 158.88mm and 307.37mm respectively. The corresponding overall irrigation efficiency is therefore 0.63, 0.72, 0.77 and 0.82 (Table 1). As a result the number of irrigations for wheat, barley, lentil and potato are four, two, three and six times during the growing season, respectively. This shows frequent application demands small amount of water and vice versa. The choice of crops under irrigation relies on the comparative benefit (or opportunity cost) of each crop. Looking the water demand of the crops in an irrigation area one can select either of the crops based on the supply of water and economic benefit. On the other hand, if the water-demanding periods for different crops vary, the potential yield is likely to increase and the potential productivity of water can be realized. For instance, the water demanding period of wheat and barley coincides during 50<sup>th</sup> to 52<sup>nd</sup>, and 90<sup>th</sup> to 96<sup>th</sup> growing days; wheat and potato during 128<sup>th</sup> to 130<sup>th</sup> days; lentil and potato during 38<sup>th</sup> to

40<sup>th</sup> (Table 2 and Fig. 4). This simultaneous requirement can result in water shortage in a specific area.

Table 1: Crop water requirement, gross and net irrigation requirement and irrigation efficiency of the different crops at Bakelo, N. Shewa

Crop	Water Requirement (mm)	Gross Irrigation Requirement (mm)	Net Irrigation Requirement (mm)	Irrigation Efficiency (%)	Gross Irrigation Requirement including pre-irrigation (mm)	Net Irrigation Requirement excluding pre-irrigation (mm)	Irrigation Efficiency (%)
Wheat	147	498.87	392.08	155.63	236.45	1.3*2 (377.16)	532.79, 3. (0.63)
Barley	135	455.94	355.95	123.44	232.51	.05*2- (324.61)	448.05, 5/ (0.72)
Potato	150	507.27	447.57	171.39	276.18	1, 3*3 (357.37)	528.76, 5, (0.77)
Lentil	110	370.23	283.65	112.21	171.43	-14*44 (208.88)	321.09, 55 (0.82)

\* & ^ --- Values in parenthesis represent gross irrigation requirement including pre-irrigation and its irrigation efficiency  
 Bold values are water requirement excluding pre-irrigation

Table 2: Irrigation frequency and amount of irrigation required at each application at Bakelo

Crop	Irrigation Frequency	Irrigation Amount (mm)	Irrigation Periods
Wheat	0.50	(Pre-irrigation, 22 <sup>nd</sup> , 52 <sup>nd</sup> , 90 <sup>th</sup> , 130 <sup>th</sup> )	(50, 41.78, 94.34, 96.78, 94.26)
Barley	0.50	(Pre-irrigation, 50 <sup>th</sup> , 96 <sup>th</sup> )	(75, 110.03, 139.58)
Potato	0.40	(Pre-irrigation, 10 <sup>th</sup> , 40 <sup>th</sup> , 59 <sup>th</sup> , 84 <sup>th</sup> , 108 <sup>th</sup> , 128 <sup>th</sup> )	(50, 20.46, 40.48, 62.51, 60.32, 61.63, 61.98)
Lentil	0.50	(Pre-irrigation, 38 <sup>th</sup> , 69 <sup>th</sup> )	(50, 76.89, 82.00)

The gross irrigation water required and the corresponding irrigation periods using soil water budget is indicated in Table 2 including pre-irrigation at planting time. This depicts the critical periods at which strategic scheduling will base on and considered as frequency of irrigation in the full supplemental irrigation. Fig. 2 indicates there is water deficit requiring supplemental irrigation during February to mid June and water surplus starts in mid June when the main season rainfall starts. Seasonal evapotranspiration (ET) starts to increase after one month of planting for wheat and lentil and 35<sup>th</sup> day for barley and potato. It continues until some days before maturity (Fig. 3). Similarly Zhang, et al, (1998) indicated that ET is less in the early stages because of the effect of only soil evaporation and increases later during vegetative growth to reproductive growth via transpiration\*

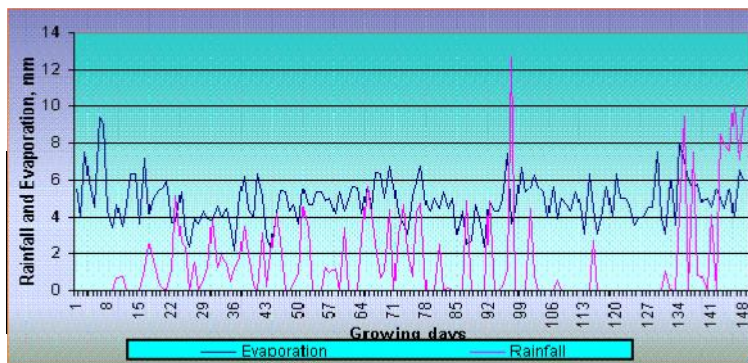

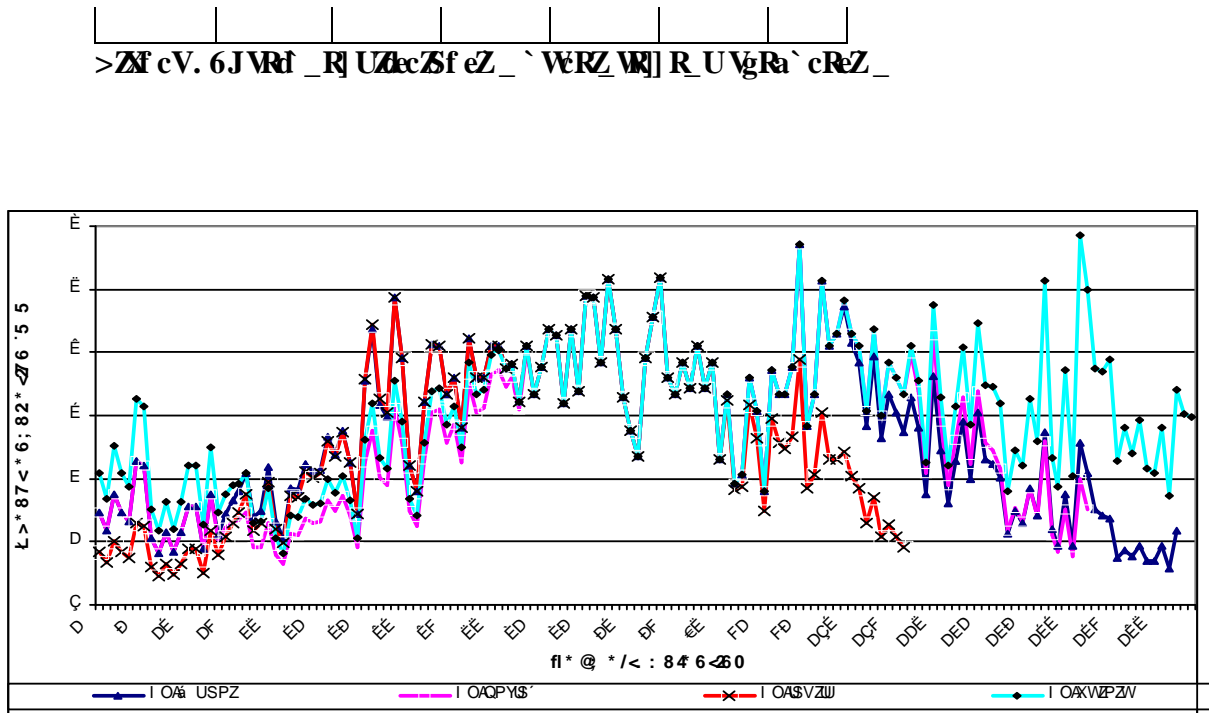

Figure 3: Daily ET of wheat, barley, lentil and potato over the growing period

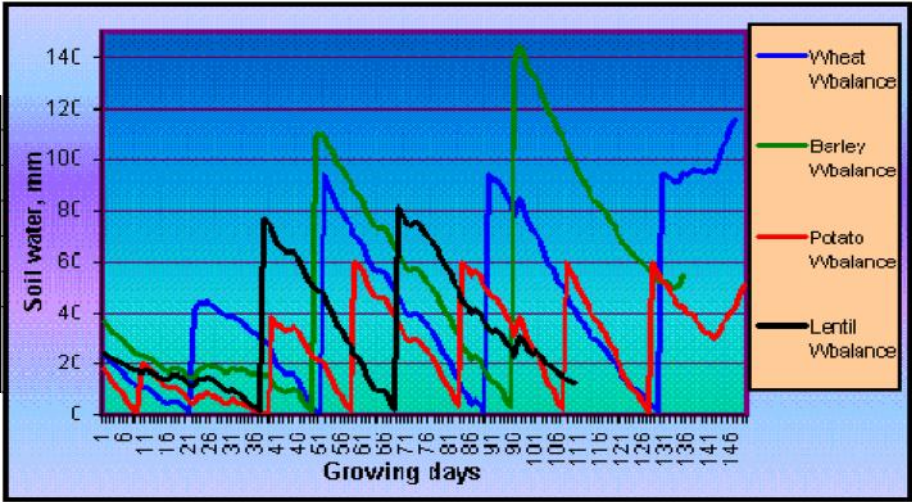

Figure 4: Seasonal water balance and distribution pattern for wheat, barley, lentil and potato

**Amount and number of irrigations**

The number of irrigations and corresponding amount of irrigation water is compared at different application regimes using soil water balance. The number of irrigations needed for wheat in full supplemental irrigation was four, on 22<sup>nd</sup>, 52<sup>nd</sup>, 90<sup>th</sup>, and 130<sup>th</sup> days after planting, (Fig. 5) compared to one to three irrigations at predetermined critical water requirement stages. The number of irrigations and amount of irrigation differ if there was

no rainfall at all during the season. Periods of irrigation when there is no rainfall for wheat is at 19<sup>th</sup>, 37<sup>th</sup>, 61<sup>st</sup>, 86<sup>th</sup>, and 114<sup>th</sup> days after planting (Fig. 5) with a corresponding amount of 35.38, 85.29, 97.72, 96.07, 94.74 mm water, respectively. It shows that an additional one irrigation is required when there is no rainfall in the season. The amount of irrigation applied at each sensitive growth stages of wheat are given in Table 4 that reduced 25-70 % of the amount of irrigation needed in full supplemental irrigation. Water balance of wheat in the five critical growth stages is given in figures 6 & 7. As it is indicated, irrigation at T1= early tillering, booting and at milk stage; and at T5 = booting and milk stage have a better water distribution pattern which in most points coinciding with the actual water balance in full supplemental irrigation. Irrigation at T3 = early tillering and milk stage has shown deficit of soil water after the first irrigation until the next irrigation. The amount of water applied for irrigation regimes at T2 = early tillering and T4 = booting was less than the net irrigation requirement of wheat (1172 and 1695 m<sup>3</sup>/ha, respectively). Their relative amount against net irrigation (2365 m<sup>3</sup>/ha) was less than 1(0.50 and 0.72, respectively). Hence the soil water distribution has indicated shortage of soil water in the tillering and immediately after heading for T4 and starting from booting for T2.

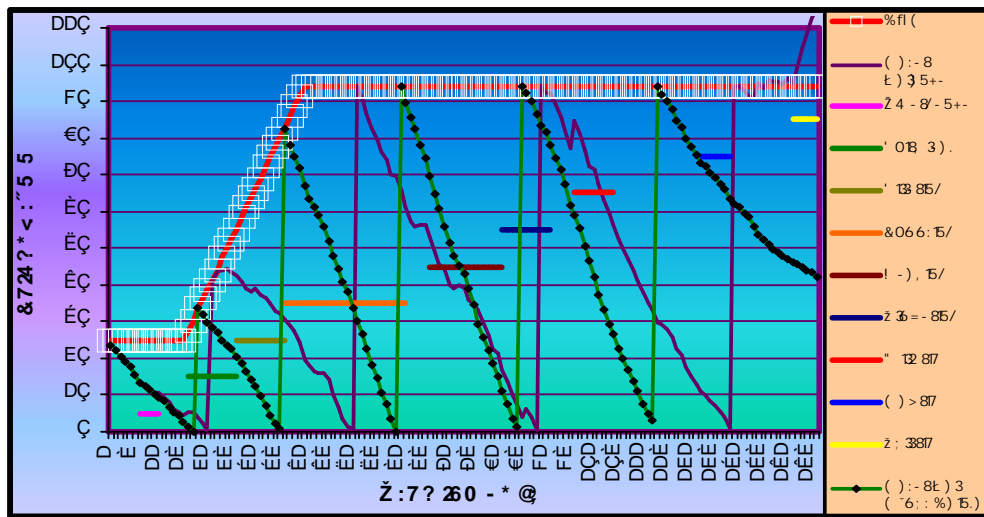

Figure 5: Seasonal water balance with and without rainfall condition in relation to wheat growth stages

Table 3: Amount of irrigation water applied (mm) at each growth stage of wheat for each treatment

KcV <sup>^</sup> V <sub>ed</sub>	GcV ZcZReZ <sub>-</sub>	=RcJj KZjVcZ <sub>X</sub> deRXV	:`eZ <sub>X</sub> deRXV	D Zj deRXV	K eRj ZcZReZ <sub>-</sub> RaaJZU
Early tillering + booting + milk stage (T1)	50	67.21	52.28	113.11	. 4. *2,
Early tillering (T2)	50	67.21	---	---	-- 3* -
Early tillering + milk stage (T3)	50	67.21	---	165.39	. 4. *2,
Booting (T4)	50	---	119.49	---	- 25*05
Booting + milk stage (T5)	50	---	119.49	113.11	. 4. *2,

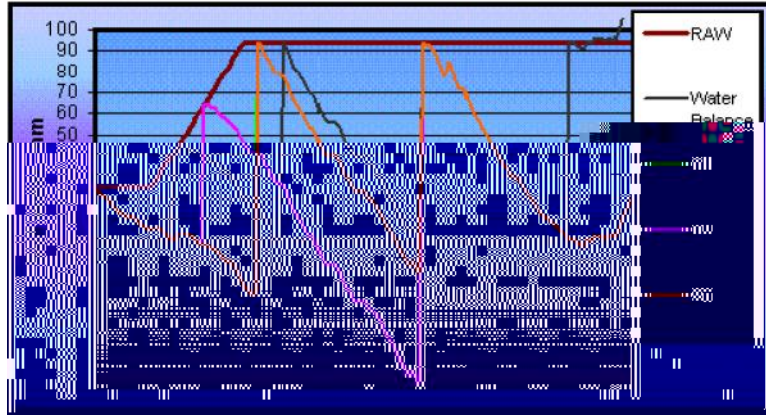

Figure 6: Comparison of actual water balance pattern for wheat with T1, T3 and T5

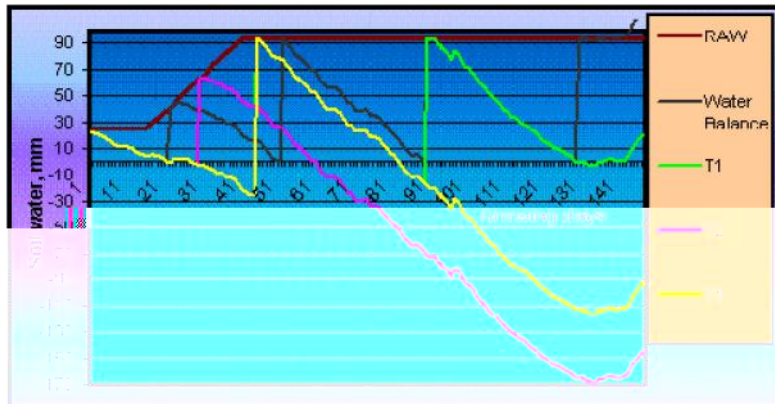

Figure 7: Comparison of actual water balance pattern for wheat with T1, T3 and T5

**OZJU` Wh YVR**

From 2002 to 2003: The crop yield data in year 2002 is given in Table 4. The third year data was not a good estimate of the reality. This was because the crop had an aphid and later bird attack. There was technical adjustment while harvesting the yield however the error could not be avoided. It had a comparable straw yield but not grain. As a result the data was not considered valid. Looking at the respective grain yields of the irrigation regimes, we observe that irrigation applied at T1 = early tillering + booting + milk stage, and T3 = early tillering + milk stage have the highest yields (2133.33 and 2100 kg/ha respectively) significantly ( $p < 0.05$ ) different from T2 = early tillering. Irrigation at T3 that depicts water shortage at booting showed good yield probably due to the rainfall occurred in the heading stage. On the other hand the grain yields of T4 and T5 were not significantly different from T1 and T2. This is because T5 has suffered from water deficit over the tillering stage. Similarly, irrigation during booting stage alone made the crop to

suffer from water deficit over tillering and grain formation stages. Irrigating wheat only during early tillering is also causing serious water stress starting from vegetative stage (Fig. 6 & 7). The water deficit at these stages is reflected on their respective grain yield (Table 4).

Table 4: Biomass, grain and straw yield of the irrigation regimes, 2002

<b>KcVr<sup>e</sup> V<sub>ed</sub></b>	<b>? cRZ j ZJU \$ XAR%</b>	<b>: Z ^ Rhdj ZJU \$ XAR%</b>	<b>JecRh j ZJU \$ XAR%</b>
Fertilized	2270.00	5233.33	2963.33
Unfertilized	1653.33	3923.33	2336.67
LSD (0.05)	NS	NS	
SE	206.73	471.03	256.14
CV (%)	10.41	12.28	14.50
Early tillering + booting + milk stage, T1	2133.33 <sup>a</sup>	4875.00	2741.67
Early tillering, T2	1775.00 <sup>b</sup>	4400.00	2625.00
Early tillering + milk stage, T3	2100.00 <sup>a</sup>	5041.67	2941.67
Booting, T4	1916.67 <sup>ab</sup>	4400.00	2483.33
Booting + milk stage, T5	1883.33 <sup>ab</sup>	4175.00	2458.33
<b>LSD (0.05)</b>	<b>250</b>	<b>NS</b>	<b>NS</b>
<b>SE</b>	<b>83.37</b>	<b>229.47</b>	<b>156.87</b>
<b>CV (%)</b>	<b>10.41</b>	<b>12.28</b>	<b>14.50</b>

Although the yield (grain) difference was high between irrigation regimes both in the fertilized and unfertilized main plots, due to large standard error there was no significant difference. Though the grain yield was not significantly different, better yield increment of 2 to 2.5 quintals was observed for irrigations at early tillering + milk stage (T3) and early tillering + booting + milk stage (T1) compared to the farmers irrigation practice represented by T5.

Year 2004: Yield of wheat only for selected irrigation application stages (T1, T3 and T5) was evaluated. Observation of wheat's vigorous condition obtained just two months after planting indicates that the two sites had similar growth condition. However, relative comparison of the irrigation application stages in its growth condition had the order of early tillering + booting + milk stages > booting + milk stages > early tillering + milk stages. The application regimes, which were not irrigated in the early tillering stage and booting stage, have showed stress condition over the next irrigation period.



Table 5: Yield of wheat obtained from supplemental irrigation application at Bakelo, 2004

Watering regime	Yield (kg/ha)	Water use (mm)	Water productivity (kg/m <sup>3</sup> )	Efficiency (%)
Early tillering + Booting + Milk stage • Three irrigations with net irrigation = -2, 4 mm; when including pre-irrigation and loss = 4.2, mm	9611.102 <sup>a</sup>	6184.988 <sup>a</sup>	3426.125 <sup>a</sup>	15.5%
Early tillering + Milk stage • Three irrigations with net irrigation = -2/3 mm; when including pre-irrigation and loss = 4.2, mm	7604.167 <sup>b</sup>	5038.905 <sup>b</sup>	2565.263 <sup>b</sup>	21.1%
Booting + Milk stage • Three irrigations with net irrigation = -2, 2 mm; when including pre-irrigation and loss = 4.2, mm	8784.717 <sup>a</sup>	5609.667 <sup>a</sup>	3175.055 <sup>ab</sup>	24.1%
LSD (0.05)	981.80	763.50	313.10	
CV (%)	8.51	10.22	7.70	
SE (+/-)	301.06	234.13	96.01	

\* Values are irrigation use efficiency of biomass yield

$$= T_1 \text{ } ^a \text{ } T_2 \text{ } ^a \text{ } a \text{ } R \text{ } T_1 \text{ } \text{ } \text{ } W \text{ } c \text{ } Z \text{ } R \text{ } Z \text{ } \text{ } W \text{ } b \text{ } f \text{ } V \text{ } T_1 \text{ } \text{ } R \text{ } e \text{ } X \text{ } \text{ } h \text{ } e \text{ } Y \text{ } d \text{ } e \text{ } R \text{ } X \text{ } d$$

Table 6: Economic comparison (costs that vary) of irrigation frequency for wheat at Bakelo, 2004

Watering regime	Cost (Birr/ha)	Early tillering + Milk stage	Booting + Milk stage
CRS <sup>c</sup> T <sub>1</sub> de Wc h R <sub>1</sub> V <sub>1</sub> Raa]Z]R <sub>1</sub> Z <sub>1</sub> \$ Z <sub>1</sub> c-YR%	511.85	487.65	404.25
? c <sup>d</sup> d]S]V W <sub>1</sub> • ? cRZ R U d <sub>1</sub> cR <sub>1</sub> j Z]U\$ Z <sub>1</sub> c-YR%	7354.43	5628.92	6778.86
Net Benefit (Birr/ha)	240.14	1-0-3	2/302-
Marginal rate of return, %	0/05.	))))	

### Recommendations

- The crop water requirements and periods at which irrigation water applied for selected crops should be utilized by the water user groups around Bakelo and Keyit irrigation farms using simple and easily application techniques and efficient system of irrigation (like drip and watering cane) until verification of these requirement by specific frequency of irrigation for each crop will be studied
- Irrigation frequency for wheat during growth stages of early tillering + booting + milk stage (T1) was found better in yield, water use

efficiency, and marginal rate of return. Thus irrigation application at these growth stages can be used for wheat irrigation scheduling in the area.

### **I W&V T&I**

- Doorenbos, J. and Kassam, A.H. 1979. Yield response to water. FAO Irrigation and Drainage paper 33, Rome Italy.
- Dupriez, H. and De Leener, P., 1992. Ways of water: Run-off, irrigation and drainage. MACMILLAN in association with TERRES ET VIE, London.
- Horst, L., 1998. The dilemmas of water division: considerations and criteria for irrigation system design. Colombo, Sri Lanka, International Water Management Institute.
- Melka Werer, 1989. Progress Report of Melka Werer research center.
- Garg, 1989. Water Resources Engineering. New Delhi
- Oweis, T., 1997. Supplemental irrigation. a highly efficient water-use practice. ICARDA, Aleppo, Syria, 16pp
- Zhang, H., Oweis, T., Garabet, S., Pala, M., 1998. Water-use efficiency and transpiration efficiency of wheat under rainfed conditions and supplemental irrigation in Mediterranean-type environment. *Plant Soil* 201, 295-305.
- Zhang, H., and Oweis, T., 1999. Water-yield relations and optimal irrigation scheduling of wheat in the Mediterranean region. *Agricultural Water Management* 38. 195-211. Elsevier



# 9 Xc` ^ VeV c` ] Xj R UI V^ ` eVJV\_dZ X

## 9 Xc` D Vec` ] XZIR R\_U; c` aaZ\_XGRceVc\_9\_Rlj dZIZ E` ceY)=RdeVc\_ GRce` W0 ^ YRcRI Vxz\_ \$ ; RIV` WE` ceYJYVh R%

Gizaw Desta and Yonas Girma

### 9 SdecRle

Recently environmental change mainly due to the climatic variation is a common phenomenon in Ethiopia. For example, the 1974, 1984, 1987, and 1995 drought caused famine and loss of agricultural production. This environmental change is mainly manifested in late onset and early offset of rainfall during the main season. Analysis of the existing and past farmers' cropping calendar, their response to the change, and comparison of the meteorological pattern to the cropping calendar were made in the north-eastern part of Amhara region. Household survey was conducted to collect required data on rainfall and cropping calendar pattern using questioner.

Farmers and those involved in the agricultural sector are more or less well aware of climate variability. The ability to understand, monitor, and predict this climate variability provides an opportunity to put historical experiences into perspective for making better decisions.

Farmers described that climate play a major role (42.16%) among the factors governing the timing of agricultural activities. Farmers characterized the current rainfall pattern by late onset and early offset (36.62 %). In all the study woredas, late onset of rainfall causing 10 to 40 days delay in the start of cropping calendar, similarly 10 to 40 days early offset were occurred in meher season. The 20 years mean monthly rainfall data of six stations also showed that the rainfall pattern became at decreasing rate. About 89.66 % of the farmers responded the occurrence of crop failure due to inadequate moisture in the season. From the total 97.67 % of the occurrence is due to the change in the onset and offset of rainfall. Responding to the change in rainfall pattern farmers were practicing in cultivating new varieties which one able to adapt the existing climatic change either because of their drought tolerance characteristics or short growing period.

The cropping calendars computed for the five stations using the soil-water balance criteria do not verify late onset and early offset of the rainfall. On average mid June and early to late November are the starting and ending dates of cropping calendar except Majetie station. Accordingly, the length of growing period becomes 130 to 155 days. The computed cropping calendar is approximately equal to the preference of the farmers indicated. However, the current starting and ending dates specified by the farmers are not ensured by the climatic data. This might be due to the fact that farmers have developed their own criteria on what soil moisture content, planting will be done for favorable crop germination.. This discrepancy calls for investigation of the criteria specific to crops and soils in order to check the climate pattern change in a better way. Otherwise, adjustments to the existing cropping calendar for the specific years and selective crops become relevant.

Keywords: Climatic pattern change, cropping calendar, onset and offset of rainfall, adjustment to cropping calendar

### A ec` Uf TeZ\_

Climate variability has a large impact on agricultural production, human health and the well-being of communities throughout the world. Therefore, research in this field has a high priority in many countries. Recently environmental change mainly due to the climatic variation is a common phenomenon in Ethiopia. For example, the 1974, 1984, 1987, and 1995 drought caused famine and agricultural losses. This environmental change is mainly manifested in late onset and early offset of rainfall during the main season and in most cases total failure of the season. In the past, the North-eastern part of the Amhara Region was more dependable on both main and short cropping seasons ( , respectively). However, in the past few decades rain fed agriculture, particularly rain, has failed to provide the minimum food requirement for the increasing population of these areas. As a result, drought affected in the north-eastern part of the region in particular increased.

On the other hand, the long-term analysis of rainfall amount shows very little difference except few years (1974, 1984, 1987, and 1995). This implies the fact that the rainfall amount is not the main problem but its pattern. Although there is clear and recurrent rainfall pattern change, the cropping calendar still remains unmodified, except some adaptation efforts at household level. Some farmers are also questioning their cropping calendar and sometimes demanding to get assistance for reliable cropping calendar. Therefore, in order to adjust the cropping calendar in relation to the climatic change, a modest pattern analysis of the long-term meteorological variables and the existing and past cropping pattern is highly required.

Research results on climatic pattern analysis so far focused mainly on rainfall and temperature at the major meteorological stations in the country. In addition, such works didn't include analysis of the existing farmers cropping calendar or the response to the change. Therefore, the intention of the study was to fill this gap by including survey on the cropping calendar and explore its adjustment made for the change.

The study aimed to analyze the past and current pattern of agro meteorological elements and cropping activities in North-eastern parts of the region, North Shewa case. The study also compared meteorological pattern to the current cropping calendar followed by farmers. By knowing these patterns it will enable us to design an adjustment of the cropping activities based on the climatic pattern.

### **D ReVZjdR U^ VY Ud**

Long-term meteorological data (1985-2004) at Alem Ketema, Enewari, Debre Birhan, Shola Gebeya, Mehal Meda, and Majetie meteorological stations were gathered from National Metreological Service Agency (NMSA). Graphical rainfall pattern analyses for the starting and ending dates were made for rainfall. The starting and ending dates of cropping calendar were computed using Instat v2.09 software. Using FAO water holding capacity map, low soil-water holding capacity range was taken for this purpose. Starting and ending dates were determined if soil-water balance  $\geq 60$  mm and  $\leq 0.5$  mm water holding capacity of the soil. A household survey technique on growing season pattern, calendar, and crop type were conducted in 13 . These are Ankober, Antsokia Gemeza, Basona Werana, Efratana Gidem, Ensarona Wayu, Gera Keya, Hagre Mariam, Kewet, Lalo Mama, Merhabetie, Mida Weremo, Moretena Jiru, and Tarmaber. The selection process of respondents involved random sampling based on the selected available in each . Eighty eight respondents were involved. The data collected was by face-to-face interview during the dry seasons of 2002-2004. The questions asked related to issues such as past and current starting and ending of rainfall seasons, preference starting and ending dates of rainfall, major crops grown and their cropping calendar, list of crops or varieties abandoned and those replacing them/newly cultivated, factors that govern timing of agricultural activities and growing period, and cope up strategies for the failure. The findings explore the knowledge of farmers on climate variability, rainfall characteristics, past and current seasonal variations and cope up strategies on the shift of crop type or crop varieties. The study further elaborates on cropping activities, the significance of seasonal shift and verifies the survey result by the rainfall and evaporation data. Water balance, starting, and ending dates of the cropping calendar for limited metreological stations were done to verify the survey data.

### **I Vdf jedR UUZIf dZ\_**

In the survey areas the sample analysis showed that crop cultivation is dominantly dependent on rain fed agriculture (75.86 %) with less dependent on supplemental irrigation (16.38 %) as well as full irrigation (7.76 %). The cropping practice is generally single cropping (61.83 %) with seasonal crop rotation practice. In some of the cases (19.08 %), double cropping was possible using the main rain season and short rainy season or irrigation. Some of the farming communities (18.32 %) are also practicing intercropping.

### **B\_`h jWUXVR UVa VcZ/ TV Wk^ Vcd`\_ TjZ ReVgRcZSZZj**

Farmers and those involved in the agricultural sector are well aware of climate variability. The ability to understand, monitor, and predict this climate variability provides an opportunity to put historical experiences into perspective and to evaluate alternative management strategies for making improved decisions to take advantage of good years and whilst minimizing the losses during the poor years

One issue is the use of seasonal forecasts for predicting when events will happen, such as the date of onset of the wet season. Timing of when events occur is of great importance in agriculture. Break of season rains often causes failure of activities in agricultural communities, such as planting of crops. Crop cultivation management is generally based on the amount and pattern of rainfall. The extent to which water is available in a season is usually considered by farmers when deciding on cropping pattern. Farmers usually take the rainfall months into account. Besides the rainfall, farmers take market price of the product in deciding the cropping pattern. In some cases, the knowledge of farmers about rainfall and climate phenomena in general is so limited that they do not know how to optimize the rainfall use in each season for the benefit of their crop production (Huda, et al, 1991; Huda, 1994; Pollock, et al, 2001). However, to some extent they have adequate knowledge on weather forecasts based on historical experiences. They usually determined weather forecast based on the moist and warm air coming from oceans and its direction.

>RIE` cdUWc^ ZZXeZ ZX` WxcZf ]ef cRj RIeZ ZAdR UXc` h ZXaVcZU

In the survey areas, farmers described that climate play a major role among the factors governing the timing of agricultural activities (42.16 %) followed by availability of oxen (41.67 %) for land preparation immediately after start of rainy season. Labor is another factor contributed 13.24 % in determining the time of agricultural activities. Soil factors related to available moisture for crop production attributed for the length of the growing period. In this respect quick drying of the soil, water logging, and/or water holding capacity of the soil determined the growing period with respective contribution of 49.51 %, 29.13 %, and 19.42 %. This signifies that the availability of

Twenty years weather data analysis for five to six stations showed that there was high variation in the starting of rainfall between specific years. But, the average starting dates of rainfall are approximately similar to the current rainfall pattern explained by farmers. Climatic pattern change in terms of onset and offset of rainfall has occurred only for specific years. Therefore, more or less the pattern of monthly rainfall data ensured the results obtained in the survey (Table 1). As a result, crop failure due to moisture stress occurred. About 89.66 % of the farmers responded the occurrence of crop failure due to inadequate moisture in the season because of 97.67 % change in the onset and offset of rainfall.

Table 2: Crops/varieties grown before the change in rainfall pattern and crops substituting them in each study

Before	After
Sorghum ( ), Maize ( ), Barley ( )	Sorghum ( ), Maize ( ), Barley ( )
Maize (Bursa), Sorghum (Afeso, Magna)	Sorghum ( )
Wheat (irrigated) Barley (irrigated)	Faba bean Lentil (irrigated)
Maize ( ) Wheat ( ) Sorghum ( ), Teff ( ) Sorghum ( )	Maize ( ) Wheat ( ) Sorghum ( ), Teff ( ) Sorghum ( )
Barley ( ), Wheat ( )	Barley ( ) Wheat (ET-13)
Wheat ( ), Barley ( )	Wheat (Isral, ET-13), Barley ( )
Sorghum ( )	Sorghum ( )
Sorghum ( ), Teff ( ), Maize ( ), Wheat ( ), Green Pepper	Sorghum ( ), Teff ( ), Maize ( ) Wheat ( ), Garlic,
Sorghum ( )	Sorghum ( )
Sorghum ( )	Sorghum ( )

### 3.2.2. Coping strategies

In response to the rainfall characteristics explained above, farmers tried to explore coping strategies or interventions when there is crop failure due to late rainfall. Among the strategies: shifting the sowing dates, cultivate crops that are able to grow on residual moisture, cultivate using irrigation are some to be mentioned. When there were failures of these options, they made ready the land for next season cultivation. The strategies were different from season to season. During cropping season, farmers tried to cope up the occurrence of late rain onset through planting on residual moisture (49.46 %), preparing the land for next season cultivation (32.26 %) and in some cases supporting with irrigation (5.38 %). In the short rainy season, , the coping strategies were mainly leaving the land for the next season cultivation (77.19 %), cultivate with the support of irrigation (12.28 %) and planting crops which have short growing period (10.53 %). Moreover farmers changed their crop types and the varieties they were adapted in the previous climatic condition. Crop varieties which are resistance to moisture deficit and are suitable to the short rainy season became newly cultivated and adopted to the current climatic condition (Table 2). When the problem became worst the farmers sold their livestock in order to avoid food insecurity.

### 3.2.3. Crop substitution

In order to see the shift in crop cultivation in rain fed agriculture due to the change in rainfall pattern, farmers were asked the starting and ending dates of the rainy season in the past and current times. Farmers were also asked their preference for the start and ending dates of the season for their cropping activities. Accordingly, comparisons were made among the past, current as well as farmers' preference starting and ending dates. Table 1 indicates the number of days by which the current rainfall pattern has changed compared to the

previous one. In all there was late onset of rainfall ranging from 10 to 40 days. Similarly 10 to 40 days early offset were occurred in meher season. During the belg season, there has been total offset of rainfall except in Ankober, Merhabetie, Efrata and Kewet Farmers indicated the preference length of growing period during which major crops able to grow with out moisture stress (Table 1). The cropping calendars computed for the five stations (Table 3) using the soil-water balance criteria mentioned above do not verify late onset and early offset of the rainfall. On average, mid June and early to late November are the starting and ending dates of cropping calendar except Majetie station. Implies the length of growing period become 130 to 155 days. The computed cropping calendar is approximately equal to the preference of the farmers indicated. However, the current starting and ending dates specified by the farmers are not ensured by the climatic data. This might be due to the fact that farmers' have developed their own criteria on what soil moisture planting will be done for favorable crop germination.. This discrepancy calls for investigation of the criteria specific to crops and soils in order to check the climate pattern change in a better way. Otherwise, adjustments to the existing cropping calendar for the specific years and selective crops become relevant.

Table 3: Cropping calendar determined from rainfall and evaporation data of the weather stations

Station	Days	Cropping Calendar		Growing Period (Days)
		Start Date	End Date	
Debre Birhan	20	June 17±14.9 days	Nov 17±24 days	152.5±32
Alem Ketema	18	June 17±11.6 days	Nov 4±18 days	140±25
Mehal Meda	18	June 19±13.8 days	Nov 23±19.5 days	156±25
Shola Gebeya	19	June 16±16.4 days	Nov 14±23 days	150.5±32
Majetie	14	June 27±27.5 days	Nov 5±12.6 days	131±35

#### References

- Huda, A.K.S. and Packham R.G. (eds), 2004. Using seasonal climate forecasting in agriculture: a participatory decision-making approach. ACIAR Technical Reports No. 59, 52 p.
- Huda, A.K.S., Packham R.G., Clewett, J.F., and George, D.A., 2004. Introduction and overview. In: Huda, A.K.S. and Packham R.G. (eds). Using seasonal climate forecasting in agriculture: a participatory decision-making approach. ACIAR Technical Reports No. 59, 52 p.

9 aaV\_UZ >Zf cV-6D VR ^ ` \_eYlj cRZ VR] aReVc \_R\_UeYVcVRz \_h ZYG=KZ\_eYVaRte j VRcd

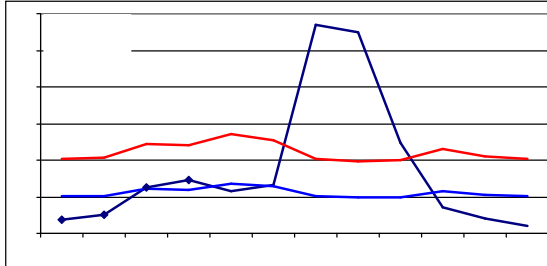
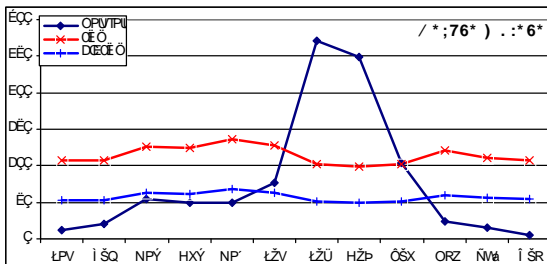
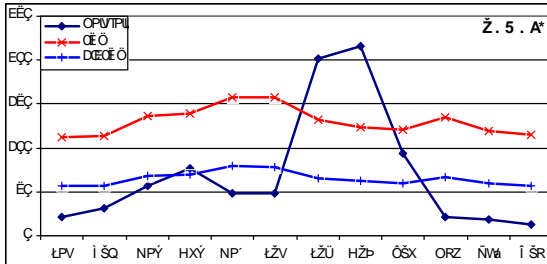
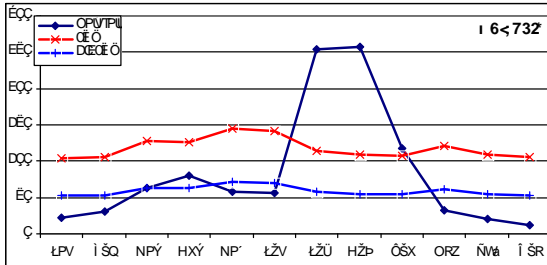
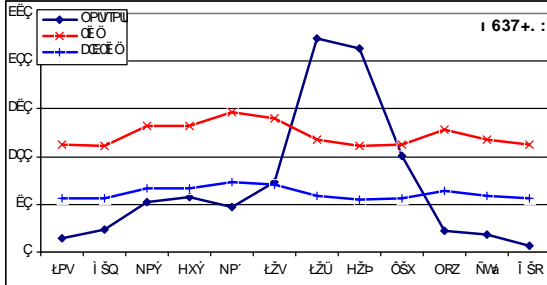

Appendix Figure 1: (contd.)

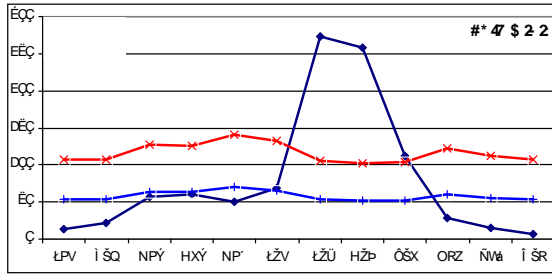

Appendix Table 1: Rainfall starting and ending dates and the length of growing period based on the rainfall and evaporation data of the weather stations

OVR	< VScV: ZYR			D WRJ D VR			9 JVA B VEV R			= _Mh RzZ			JY JR? SVJ R			D R WZV		
	JeRte	=_U	C? G	JeRte	=_U	C? G	JeRte	=_U	C? G	JeRte	=_U	C? G	JeRte	=_U	C? G	JeRte	=_U	C? G
1985	2-Jul	24-Dec	175	3-Jul	16-Oct	105	1-Jul	8-Nov	130				19-Jun	27-Oct	130	8-Jun	27-Oct	141
1986	1-Jun	17-Nov	169	2-Jun	23-Nov	174	20-Jun	23-Oct	125				2-Jun	23-Oct	143	25-Jul	26-Oct	93
1987	5-Jul	*	*	4-Jul	*	*	5-Jul	14-Oct	101				13-Jul	15-Nov	125			
1988	2-Jun	24-Nov	175	2-Jun	13-Nov	164	6-Jul	3-Oct	89				5-Aug	6-Oct	62	14-Aug	14-Oct	61
1989	8-Jun	2-Dec	177	8-Jun	*	*	7-Jun	24-Nov	170				5-Jun	12-Nov	160	8-Jul	23-Nov	138
1990	1-Jul	16-Nov	138										1-Jun	29-Oct	150	1-Aug	4-Nov	95
1991	21-Jun	18-Nov	150										20-Jun	2-Dec	165	5-Jun	3-Nov	151
1992	15-Jul	18-Oct	95	29-Jun	12-Dec	166	29-Jun	30-Nov	154				7-Jun	31-Oct	146	10-Jun	29-Oct	141
1993	5-Jun	*	*	4-Jul	1-Dec	150	3-Jun	21-Nov	171				19-Jun	26-Nov	160	2-Jun	19-Nov	170
1994	5-Jun	19-Oct	136	25-Jun	15-Dec	173	20-Jun	23-Oct	125									
1995	1-Jun	*	*	1-Jun	*	*	1-Jun	25-Oct	146				2-Jun	17-Nov	168			
1996	5-Jun	20-Oct	137	4-Jun	4-Nov	153	4-Jun	23-Oct	141				4-Jun	30-Oct	148			
1997	1-Jun	30-Dec	212	1-Jun	*	*	2-Jun	8-Dec	189				2-Jun	26-Dec	207			
1998	25-Jun	21-Nov	149	25-Jun	27-Nov	155	21-Jun	13-Oct	114				24-Jun	22-Dec	181			
1999	21-Jun	2-Dec	164	2-Jun	31-Dec	212	24-Jun	18-Nov	147	6-Jul	1-Oct	87	2-Jun	17-Dec	198			
2000	24-Jun	*	*	28-Jun	6-Nov	131	19-Jun	5-Nov	139	7-Jul	2-Oct	87	24-Jun	10-Dec	169	1-Jun	30-Nov	182
2001	26-Jun	*	*	26-Jun	25-Nov	152	10-Jun	23-Oct	135	9-Jun	4-Nov	148	11-Jun	*	*	12-Jun	7-Nov	148
2002	4-Jun	18-Nov	167	10-Jul	22-Nov	135	4-Jun	8-Nov	157	24-Jul	1-Oct	69	14-Jun	1-Nov	140	17-Jun	3-Nov	139
2003	2-Jun	*	*	21-Jun	*	*	21-Jun	11-Nov	143	16-Jun	28-Oct	134	21-Jun	30-Oct	131	2-Aug	2-Nov	92
2004	11-Jul	10-Oct	91	18-Jun	19-Nov	154	19-Jun	13-Nov	147	22-Jun	1-Oct	101	19-Jun	28-Oct	131	3-Jun	31-Oct	150
<b>D VR</b>	<b>17-Jun</b>	<b>17-Nov</b>	<b>152.50</b>	<b>19-Jun</b>	<b>23-Nov</b>	<b>155.69</b>	<b>17-Jun</b>	<b>4-Nov</b>	<b>140.17</b>	<b>29-Jun</b>	<b>11-Oct</b>	<b>104.33</b>	<b>16-Jun</b>	<b>14-Nov</b>	<b>150.78</b>	<b>27-Jun</b>	<b>5-Nov</b>	<b>130.85</b>
<b>JeUVg</b>	<b>14.92</b>	<b>24.34</b>	<b>32.34</b>	<b>13.83</b>	<b>19.54</b>	<b>25.24</b>	<b>11.62</b>	<b>17.99</b>	<b>24.57</b>	<b>16.47</b>	<b>15.78</b>	<b>30.49</b>	<b>16.35</b>	<b>23.19</b>	<b>31.88</b>	<b>27.49</b>	<b>12.60</b>	<b>34.94</b>



Appendix Table 2. Current, previous and preference rainfall starting and ending dates for rain fed agriculture at different

	GeVgZfd ^ VVc deReZ_XURv	GeVgZfd ^ VVc V_UZ_XURv	GeVgZfd SVX deReZ_X URv	GeVgZfd SVX V_UZ_X URv	; fccV_e ^ VVc deReZ_XURv	; fccV_e ^ VVc V_UZ_XURv	; fccV_e SVX deReZ_XURv	; fccV_e SVX V_UZ_XURv	GcWwV_TV ^ VVc deReZ_XURv	GcWwV_TV ^ VVc V_UZ_XURv	GcWwV_TV SVX deReZ_X URv	GcWwV_TV SVX V_UZ_X URv
<i>Woreda</i>												
<i>Ankober</i>	Early June to early July	Mid September to early October	Early November to mid January	Late January to early May	Early to mid July							

Appendix 3. Cropping calendar of the major crops in the irrigated and rain fed production systems

M' cUR	Kj aV `W ; c' a ejaV R&cZf jef cV	CR UacV a R e Z _de	V a R e Z				J' h Z XUR e V	MWUZ X e Z V	@R g V e Z X		
			Jan	Feb	Mar	Apr					
	Irrigated	Onion	Nov.	Dec.	Jan.			Late Jan-Feb	Feb - Mar	May – June	
		Pepper	Jan	Feb	Mar			April	Late April - May	October	
	Rain fed	Barley	Jan	Feb	Mar	April	May-June	July	Sept	Oct	
		Teff	Jan	Feb	Mar	April	May-June	Late July	Aug	Early Oct-Nov	
		Maize	Jan	Feb	Mar	April	May-June	Late June-July	Late July-Aug	Oct-Nov	
		Wheat	Jan	Feb	Mar	April	May-June	July	Aug	Oct-Dec	
		Lentil	No	Land	prepared			July	Not needed	Late Sept-Nov	
		Chickpea	July	Aug				Late Aug-Early Sept	Sept	Nov-Dec	
		Haricot bean	No	Land	prepared			July	Not needed	Oct	
		Faba bean	No	Land	prepared			June-July	July-Aug	Oct-Nov	
		Sorghum bicolor	Jan	Feb-Mar				April	May-June	Nov-Dec/Jan	
		Mung bean	No	land	prepared			Feb	Not needed	May-June	
	Sesame	No	land	prepared			April	June	Oct		
	Rain fed	Barley	Oct	Nov				Dec-Jan	Feb-Mar	May-June	
		Teff	Oct	Nov	Dec	Jan		Feb-Mar	April	Late May-June	
		Maize	Dec					Jan-Feb	Feb-Mar	June	
		Wheat	Oct	Nov				Jan-Feb	Feb-Mar	May-June	
		Lentil	No	Land	prepared			Feb	Not needed	May-June	
		Chickpea	Nov	Jan				Feb-Mar	Mar-May	May-June	
	Lalo Mama	Rain fed	Barley	April	May-June				June	July-Sept	Nov
Wheat			Mar-Apr	Apr-May	June			July	Aug-Sept	Late Dec-Jan	
Faba bean			No Land preparation						June	Aug - Sept	Late Nov-Dec
Garlic			April	May-June				June-July	Aug-Sept	Nov-Dec	
Potato			April	June				June	Aug	Oct - Nov	
Field pea			Mar	April				June	Not needed	Dec	
Flux			Apr-May					June	Not needed	Dec - Jan	
Rain fed		Barley						Sept	Not needed	March	
Wheat								Sept	Not needed	March	
Moret-Jiru (Kolla)		Irrigated	Pepper	Sept	Oct	Nov	Dec		Jan	After 10 day/4X	Mid May-June
	Tomato		Oct					Oct	After 30 day/3X	Late Jan	
	Maize		Jan	Feb				Jan-Feb	Mar-Apr	May-June	
	Teff		Jan-Feb					Feb	Mar	April-May	
	Rain fed	Onion	Sept	Oct				Oct-Nov	After 20 day/6X	Mar-Apr	
		Teff	Jan-Apr	May	June			July	Late Aug-Sept	Oct-Dec	
		Sorghum	Jan	Mar				June-Early July	July-Aug	Nov-Dec	
		Sesame	Jan	May	June			July	Late Aug-Sept	Nov-Dec	
Noug	No land	Preparatio					June-early July	Not needed	Late Oct-Nov		
Onion	May-Jun						July	Mid July-Aug	Oct		

Appendix Table 4 (contd.)

Gera Keya	Rain fed	Sorghum	Jan	Mar			Mar-Apr	June, Aug	Dec	
	Irrigated	Pepper	Sept	(Oct.)			Oct	Oct-Nov	Feb-April	
		Tomato	sept				Oct	Oct-Nov	Mar	
		Maize	Sept				Sept-Oct	Oct-Dec	Feb-Mar	
		Teff	Mar				Early Mar	Mar-apr	June	
		Onion	Sept				Oct	Nov	Apr	
	Rain fed	Barley	Mar	Apr-May			June-July	July-Aug	Oct-Dec	
		Teff	Mar	July			July	Late Aug	Early Oct-Nov	
		Chikpea	Aug				Sept	Oct	Jan	
		Wheat	Mar	Apr-May			July	Mid Aug	Nov-Jan	
		Lentil	May/none				June-July	Not needed	Oct-Dec	
		Grass pea	May-June				Sept	Not needed	Feb-Mar	
		Field pea	No land preparation					June	Not needed	Oct-Early Dec
		Faba bean	Feb-mar				Mid May-June	Mid July-Aug	Late Oct-Jan	
		Sorghum bicolor	Jan	Feb			Mar-Apr	Apr-May, Aug-Sept	Nov-Dec	
		Flux	April				June	Not needed	Dec-Jan	
		Potato	May-June				July	Aug-Sept	Nov	
		Garlic	May-Jun				July	Mid July	Late Dec	
	Onion	May-Jun				July	Mid July	Late Dec		
Rain fed	Barley	Sept	Oct			Jan-Feb	Not needed	May-June		
	Wheat	Sept	Oct			Jan-Feb	Not needed	June-July		
	Lentil	Sept	Oct			Jan-Feb	Not needed	May-June		
Mida Oromo	Irrigated	Pepper	Sept				Jan	Feb-Apr	May	
		Onion	Nov	Dec			Jan	Feb-Apr	May	
	Rain fed	Barley	Apr-May	June				Early June-July 10	July 22	Early-late Oct
		Teff	Mar/April	May/June	July			Early July-mid Aug	Mid Aug-Early Sept	Late Oct-Nov, Jan-Feb
		Wheat,	Mar/April	May	June			July 27-Aug 20	Sept-Oct	Jan-Feb
		Wheat	April	May	June			Mid-end of June	Early-Mid Aug	Nov
		Wheat, white	April	May	June			July 10-25	Early Sept	Nov
		Grass pea	No land preparation					Mid Sept	Not needed	Jan-Feb
		Field pea	No land preparation					June-Early July	Not needed	Mid Oct
		Faba bean	June/No land preparation					June 20-July 8	Not needed, Mid July-Early Sept	Oct-Nov
		Sorghum	May	June				Early June-Early July	Aug	Nov-Dec
		Chickpea	Apr-May/No land preparation					Sept	Not needed	Jan-Feb
		Sesame	May	July				Mid-Late July	Mid Aug-Early Sept	Nov-Dec
		Lentil	No land preparation					July	Aug	Early Oct-Nov
	Rain fed	Sorghum bicolor	Jan					Mar-Apr	May-June	Nov-Dec
		Sorghum	Jan					March/May	April/June, Aug	Dec-Jan

## >` cVdecj -9 Xc` WcVdecj

Jef Uj ` \_ A UZV` f dKcWR UJYcf S Ja VIZd` W Yf cTYd(R UD ` \_RdeVZd` W  
MRX)CRdeR< ZecZle

Haile Adamu

Sekota dry land agricultural research center, Weldia, Ethiopia

### A ec` UF TeZ`

It is a common scenario in Ethiopia that forest areas composed of indigenous trees and shrubs are dwindling at an escalating rate as a result of high population pressure and its related consequences like the need for agricultural land, settlement, fuel wood, house construction, income generation, and for other needs. Besides, absence of strong forest policy adding with the change in the climatic condition of the country made the problem sky high. Such a depletion of indigenous trees and shrubs is seen pronounced in some parts of the country including Wag-Lasta district.

Nevertheless, there are some places like parks, reservation areas, universities and colleges, embassies, sacred places like churches and monasteries, and other restricted areas which harbor so many indigenous trees and shrubs species.

Actually these days a lot of professionals were engaged in dealing with churchyard forest ecology (Taye Bekele, 1998; Asseged Bezabih and Taye Bekele, 2001; Dagnachew Gebeyehu, 2001; Alemayehu Wassei, 2002). In deed it is possible to say that forest ecologies that we are left with are the Ethiopian Orthodox Church compounds. Although the main purpose of churches is being a center for worship, burials and mediating religious festivals, they also provide valuable and often unique secured habitats for plants and animals, as well as microorganisms and green spaces for people to test the stressed mind (Alemayehu, 2002). One can postulate that after a full deforestation in Ethiopia the final founders of indigenous trees will be Churches and Muslim burial grounds. Ethiopian Churches and Monasteries establishment is the last refugee for hundreds of species of plants and animals, (Alemayehu, 2002).

The churches and monasteries of Wag-Lasta district are the conspicuous sites in the district that harbor so many numbers of indigenous tree and shrub species. It is located at about 12° 32' and 39° 04' E and situated at about 720 km north of Addis Ababa. It has rugged topography dominated by rock outcrops with mountainous terrain and high plateaus dissected by river basins. Due to its rugged topography, it is one of the areas with the highest rate of soil erosion in the country.

Land degradation is rife as a result of over exploitation of the woodlands and farming of the fragile hill slopes. Transgression of agriculture towards the steeper slopes of the mountains resulted in the clearing of forests for centuries. This in turn has accelerated soil erosion and destroyed the soil and vegetation of the area. The woodlands have been and still are the major sources of wood for fuel and construction.

The annual rainfall, recorded between 1997 and 2000, ranged between 349 to 643 mm for Sekota (Tefera, 2001). The rainfall is concentrated in the months between June and August while the remaining nine months are apparently dry. The soil is generally dominated by infertile, coarse textured sandy soils.

The vegetation in the area has been categorized under the Juniperus/Olea Forest within Welo Dry Juniperus Forest Seed Zone (Aalbaek, 1993). Broad-leaved species are

dominating whereby the family Fabaceae is a significant contributor to the biomass of the area. Several species of *Acacia* (*A. abyssinica*, *A. albida*, *A. seyal*, *A. tortilis*, etc.), *Albizia gummifera*, *Celtis africana*, *Cordia africana*, *Croton macrostachyus*, *Dodonaea angustifolia*, *Ekebergia capensis*, *Erythrina abyssinica*, *Euphorbia candelabrum*, *Hagenia abyssinica*, *Juniperus procera*, *Olea europaea* subsp. *cuspidata*, etc. are dominating (Aalbaek, 1993). The vegetation in the area could be categorized under dry *Acacia*-dominated Afromontane forest (Friis, 1992; Kebrom, 1998). The objectives of the study, therefore, were to collect information on the availability and status of indigenous trees and shrubs; and to assess opportunities of obtaining seed sources of indigenous trees and shrubs for the future research and development works

## **2.2.1. Study Area**

### **2.2.1.1. Study Area**

Site selection was handled through series of steps. First the whole church data in the mandate area was recorded. Secondly, ancient churches that are greater than 30 years of age were recorded. Third, information on churches' and monasteries' natural forest, which may have greater than 1.5ha were collected from the district agricultural offices. Then at office level sample churches were distributed evenly across the altitudinal ranges of the research mandate area. Finally 7 churches were selected for survey.

### **2.2.1.2. Sampling Design**

The general sampling design employed was systematic-stratified design. Actually the sampling designs employed in some forest fragments were deviated from the general design due to forest composition and land terrain feature. Transects were laid down in 100 m interval and a 100 m<sup>2</sup> circular plots and 16 m<sup>2</sup> subplots were employed at each 50 m interval in each transect. Occasionally, the gap 50 m and the shape 100 m<sup>2</sup> circular plot were corrected for ease of survey.

Churches have been selected by stratifying them in to Kolla, Weyna dega and Dega agroecologies. In such a way, two churches were selected in each agroecological zones of Weyna dega and Dega and only one monastery was selected for Kolla agroecology depending on the availability on church and monastery forest in the mandate area.

### **2.2.1.3. Data Collection**

In each plot species were identified and height and DBH were recorded in each plot. Taking a 4×4 m sub-plot in each plot, sapling and seedling counts were recorded. Moreover, other important data of every tree and shrub species were collected through questionnaire.

### **2.2.1.4. Data Analysis**

#### **Species identification**

Species were identified using the manuals entitled *Useful Trees and Shrubs for Ethiopia* (Azene, 1993), *Flora of Ethiopia*, Vol. 3 (Hedberg and Edwards, 1989), *Flora of Ethiopia and Eritrea*, Vol. 2 Part 2 (Edwards, et al, 1995) and *Flora of Ethiopia and Eritrea*, Vol. 4 Part 2. Thus, nomenclature followed were that of Azene (1993), Hedberg & Edwards

(1989, 1995), Edwards et al. (1997), Edwards et al. (1995), Friis (1992) and Woldemichael Kelecha (1980).

***Species richness and Diversity indices***

Shannon Diversity Index and Simpson Diversity Index were used. Species richness is estimated with the total number of observed species. The Shannon Diversity Index is calculated by multiplying a species proportional abundance by the natural log of that number:

$$H = -\sum p_i \ln p_i$$

Where  $p_i$  is the proportion of individuals found in the species “i”. This index assumes that individuals are sampled randomly from an infinite or very large population. Similarly, it supposes that all species are represented in the sample. The value of the Shannon Diversity Index usually falls between 1.5 and 3.5 and only rarely exceeds 4.5.

The Simpson Diversity Index is defined as the sum of squares of proportion abundance of each species:

$$D = \sum p_i^2$$

As  $D$  increases, diversity decreases. Therefore, the Simpson Diversity Index is usually expressed as  $1 - D$  or  $1/D$ . Where  $1 - D$  is used as the index, it ranges from 0 to 1, with values close to 1 showing a community of many species with equally low abundances while numbers close to 0 express fewer species with one of them clearly dominant.

***Basal area, species density and regeneration status***

Basal area for each species was analyzed using the formula:  $BA = \pi D^2/4$ . And the basal area per hectare was analyzed using the formula:  $G = \pi/40000 * \sum D^2/a$ . Species density was summarized from total number of individual abundance in each species. .

Regeneration status was analyzed by looking at the tree diameter size distribution known to be population structure. Normally it shows the proportion of seedlings, saplings and mature tree for each species in all churches. Population structure or tree stem diameter distribution has been used to infer past disturbances, regeneration patterns and successional trends in tree populations (Tamrat, 1994; Demel, 1997a; Mekuria et al., 1999; Tadesse et al., 2000; Feyera et al., 2002). Besides, the diameter distribution can be used to construct stand tables and estimate stand volumes of a wide range of products. A diameter size class distribution that drops exponentially with increasing diameter at breast height (DBH) is characteristic of species with good rejuvenation (Kebrom, 1998). Such a distribution is often referred to as an inverse J-shaped distribution. In contrast, flatter distribution curves indicate a lack of recruitment and perhaps changes in species composition (Tamrat, 1994; Demel, 1997a).

***I Vef ]ed R\_U < Zlf dtZ \_***

According to Shannon diversity indices, only Barkidane Mihret monastery has a good number of tree and shrub species but the other church forests are covered by a kind of forest which is dominated by a very few number of species. For example, only 5 tree and shrub species were discovered from each churches of Yimrhane Kiristos(50 plots) and Ayna Eyesus(62 plots). The difference in their species richness and diversity between

Barkidane Mihret monastery and the other surveyed churches is due to their difference in agro-ecological location, and difference in management. Regardless of their difference in altitudinal location, Ayna Eyesus (at 5 species) from Weyna Dega and Yimrhane Kiristos( at 5 species) from Dega reflects similarity in their species richness and diversity. The main reason for their similarity could be other factors like, soil, slope and management of the areas. Meanwhile, the presence of only saplings and seedlings with out their respective mature ones in almost all churches might reflect that succession is or will taking place between very important indigenous trees and less quality shrubs.

### Ja VIZd cZY\_Vd( R\_UUZ\_VcdZj

The highest shannon diversity indices exhibited in the Kolla agroecology of Barkidane Mihret at a value of 2.5 and of course it has the highest number of species among the churches though it has the lowest number of plots (Table 1). The remaining churches, except the Asketema church of Weyna Dega agroecology, have below 1.5. Generally, there is a general difference in species richness and diversity across agroecological locations though Dega and Weyna Dega show similarity (at Dega=23 species from two churches, Weyna Dega=18 species from two churches, and Kolla=20 number of species from one monastery which is the smallest number of plots).

Table 1: Species richness and diversities in the communities.

	<=? 9		MVj_RUVXR		∖` jJR
	ER f è CVMS	OZ cYR_VB Zcè d	9 j_R=j Vfd	9 d Vev^ R	: R\ ZR_VD ZcVe
Plot number	62	50	62	19	14
Individuals	207	262	316	131	67
Species	18+4*	5+4*	5+16*	13+5*	20+8*
Sapling	42+19*	52+15*	142+43*	58+23*	57+7*
Seedling	164+124*	29+162*	131+490*	1263+103*	73+13*
SW diversity	1.48945	0.536	0.629	1.83712	2.495
Simpson's diversity	0.38928	0.715	0.60365	0.18515	0.12939

- Where \* is the number of saplings and seedlings that does not have representative matured individuals.

### : RIR R\_VRR\_UUV\_dZj

Basal area (BA) varies from 0.028 m<sup>2</sup> at Ayna Eyesus to 1.192 m<sup>2</sup> at Yimrhane Kirstos. Basal area per hectare varies from 78.45 m<sup>2</sup> at Asketema to 693.41m<sup>2</sup> at Yimrhane Kirstos(Table 2).

There were totally 63 species in the surveyed area. The species density varies greatly, ranging from 1 (for 15 species) to 525 stems for (Table 2).

Table 2: Total species, individuals and basal area at each site and per hectare

	< VXR		MVj_RUVXR		B` jJR
	ER f è CVMS	OZ cYR_VB Zcè d	9 j_R=j Vfd	9 d Vev^ R	: R\ ZR_VD ZcVe
Species	18	5	5	13	20
No. of individuals	207	262	316	131	67
BA	0.041	1.192	0.028	0.039	0.066
BA/ha=G	265.754	693.41	481.27	78.45	132.72

## **KcWG af jRZ\_ Jecf Tf cV**

As already mentioned Population structure or tree stem diameter distribution has been used to infer past disturbances, regeneration patterns and successional trends in tree populations (Tamrat, 1994; Demel, 1997a; Mekuria et al., 1999; Tadesse et al., 2000; Feyera et al., 2002). A diameter size class distribution that drops exponentially with increasing DBH is characteristic of species with good rejuvenation (Kebrom, 1998). Such a distribution is often referred to as an inverse J-shaped distribution. In contrast, flatter distribution curves indicate a lack of recruitment and perhaps changes in species composition (Tamrat, 1994; Demel, 1997a).

In the case of Wag-Lasta churches, the stem diameter size distribution does not show an inverse J-shaped distribution for the dominant species such as

and . The diameter class distributions exhibited different trends from species to species within a church forest and among church forests, even for the same species (Fig. ). The major observed diameter distributions observed are: species having individuals only at the lowest class or the two lowest classes, or species having a high proportion of individuals at the lowest class and a sharp decline at the next class/classes followed by a gradual decline in the number of individuals towards the next classes. In many instances there are populations where species having a high proportion of individuals at the lowest class and a sharp decline at the next class/classes followed by a gradual decline in the number of individuals towards the next classes , but with missing individuals at one or several of the classes.

In undisturbed natural forests, it is common to see the number of seedlings, number of saplings, number of matured ones for a species. However, in the case of this study the reverse was true. As seedling-sapling-mature tree and shrub pattern graphs shows very irregular patterns in almost all the species in all churches and monastery except *Olea Africana* of Ayna Eyesus seems proportional(100-100-89). This reveals that the perpetuation of the species is questionable unless urgent silvicultural measures take place like improving gene pool, viability of soil seed bank, thinning and the likes. Further the data shows forest stewardship problem of the churches and monasteries. And hence, there is the need to revise the stewardship system of church and monastery forests.

Tree population structure also called diameter distributions of trees, number of trees over diameter at breast height, are strongly related to forest structure and disturbance history. They have been successfully used in distinguishing young, mature, and old-growth stands, in measuring similarity to old-growth structure, and in describing successional pathways and structural development (Demel, 1992). The reverse J-shaped form has been traditionally considered an essential feature of balanced, uneven-aged diameter distributions; on the other hand there are deviations from this curve in a steady state condition.

The two parameter Weibull distribution function was used to model the diameter distribution of the dominant tree species in the church forests of Wag-Lasta

$$F(x) = 1 - e^{-(x/\beta)^\alpha}$$

This distribution is characterized by the distribution function  $F(x)$ , the number of trees at DBH class  $x$ , the scale parameter  $\beta$ , the slope parameter  $\alpha$ , and the DBH(x) in cm. This function is very successful in fitting stem-size distribution data and is popular with



modelers dealing with uneven-age stands. Most forms of the distribution show either a simple decline or a unimodal form. Depending on the shape parameters, the distribution is skewed to the left, symmetrical, or skewed to the right. The scale parameter ( $\beta$ ) is approximately equal to the median DBH while the shape parameter controls the skewness of the distribution. When the shape parameter becomes less than 1 the curve approaches an inverse J-shape distribution. Model parameters were determined by means of linear regression and maximum likelihood methods (Sheil and Salim, 2004). The disparity between the observed and the predicted distribution and between sites was explained by the responsible ecological factors (Lykke, 1998; Swaine, 1998).

The mean value of the scale parameter  $\beta$  approaches the median value, and the value of the scale parameter shows skewness. When the value of the scale parameter is less than 1 it will be skewed to the right and approaches inverse J-shaped distribution. Most of the shape parameters showed skewness to the right, their peak towards the higher diameter classes. Tree diameter distribution fitted with the two parameter Weibull distribution function.

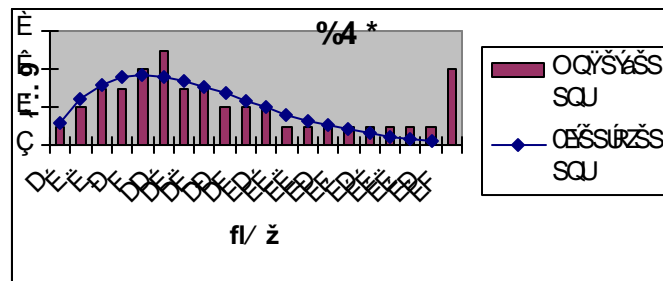

Figure 1: Tree diameter distribution for f or the Asketema church

Despite the presence of good number of individuals in the middle and upper diameter classes, there is lack of individuals in the lower diameter class may be due to trampling by human or lack of favorable environment for the establishment of seedlings, may be due to lack of viable seeds or soils moisture.

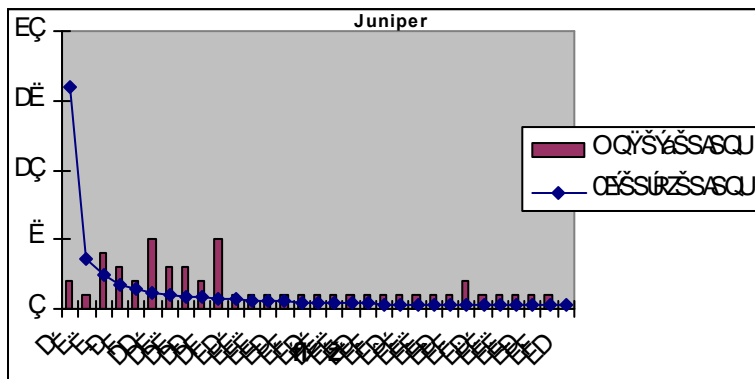

Figure 2: Tree diameter distribution for Juniperus procera for the Asketema church

The same trend is observed on Juniper. The only difference may be it has an inverse j-shaped distribution, but with great disparity between the observed and predicted values. The same biotic and abiotic factors might have been responsible for the observed population structure.

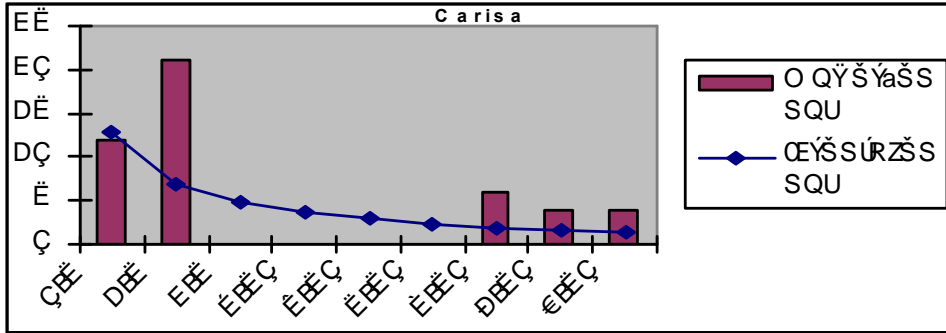

Figure 3: Tree diameter distribution for Carisa edulis for the Asketema church

When it comes to the diameter distribution of the shrub species, it is found in good condition. The observed number of individuals is higher than the predicted one, and yet with great variation between the observed and the predicted one. This observed population structure might be due to species specific virtues such as being thorny and having low quality wood, or the ability to germinate its seeds in harsh environments.

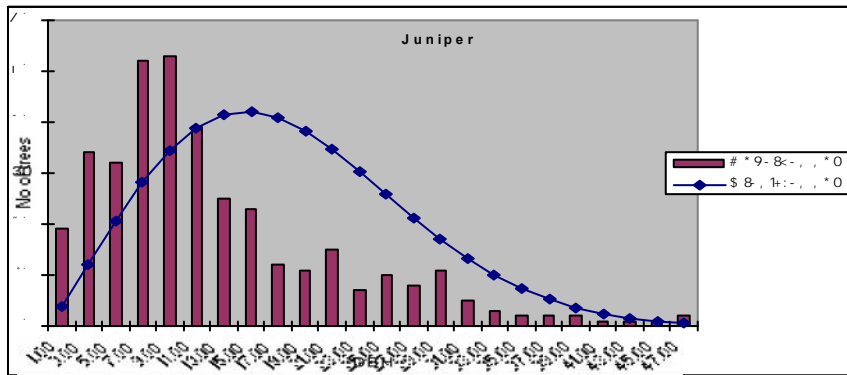

Figure 4: for the AynaYesus Church

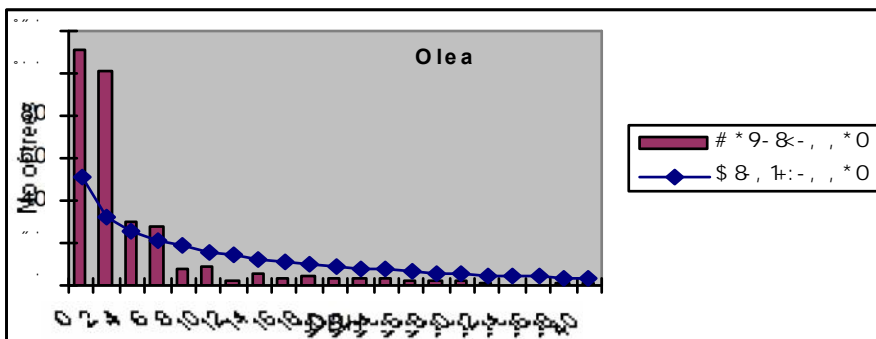

Figure 5: for the Aynayesus Church

There is no as such remarkable difference between the observed and predicted diameter distribution at AynaYesus. Juniper is under estimated at the lower diater class and over estimated in the higher diameter classes. This might be due the secession of deleterious factors responsible for the death of seedlings such as trampling by human and livestock, or closure of the area.

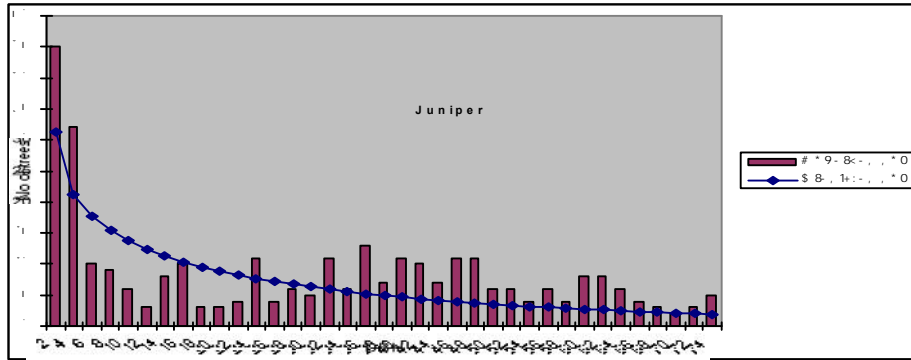
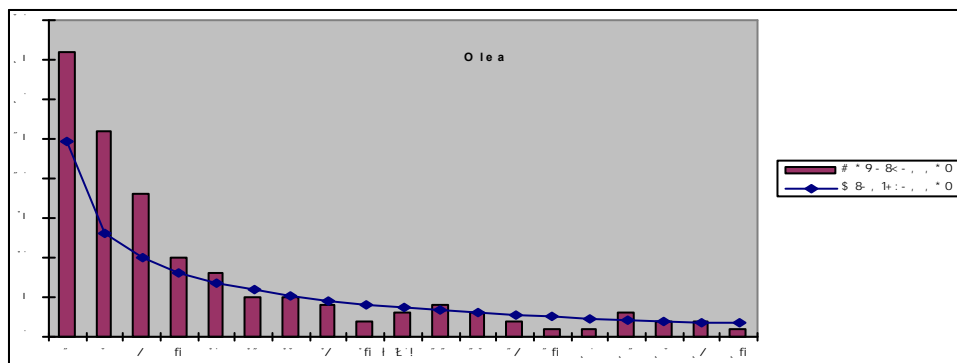

Figure 6: diameter distribution for the Yemerahene-Kerstos church



diameter distribution for the Yemerahene-Kerstos church

The tree diameter distribution of the dominant species at Yemerahene-Kerstos showed typical J-shaped distribution which is supposed traditionally as an essential feature of balanced, uneven-aged diameter distributions. The fact that the church is located far away from urban areas, and its importance as a religious figure, contributed for the observed tree population structure. As far as silvicultural management in the population is concerned, there might be a need to thin some individuals in the 20-40 cm diameter class so that it will have typical inverse J-shaped distribution.

**: RRR RVR R\_UJa VIZd UV\_dZj**

All the churches and monastery exhibited basal area per hectare ranging from 78.45 in Asketema to 693.41 at Yimrhane Kiristos. This reveals that there is a good stands of forest except for Yimrhane Kirstos and Ayna Eyesus which are over stocked. Further more, the data on the two churches show the need to take urgent appropriate silvicultural measures like thinning and others.

Only two species, ( ), totally controlled about 82.55% of the total stand density. And only six species covers about 10.56%. The rest 55 species (87.30% out of the total number of the species), covers below 10% of the total density in total. This can further disclose that the church forests are dominated by a large number of rare species. Existence of these much rare and unique species indicates the severity of species threat all over the sampling units.

; ` \_Tjf dZ \_ R UI VI ^ ^ V URZ \_

To safeguard the dying species and keep up the potentials the following conclusion and recommendations are forwarded.

- Silvicultural measures like enrichment plantation: in almost all surveyed churches, it is observed that the forest were dominated with old aged trees that shows the dying nature of the whole church forest in the near future unless urgent silvicultural measures like enrichment plantation, thinning and the likes are taking place.
- Improvement of the gene pool and viability of soil seed bank is paramount to perpetuate the species. Poor in the genetic pool and soil seed bank viability of the species might be one reason that made the domination of old aged trees and shrubs. Otherwise the perpetuation of the species in such a way is questionable
- Attitudinal change in stewardship system of church forest: there is frustration from the priest and community that planting seedlings inside the forest brings the wrath of God rather only guarding is safe and blessing. The forest is there untouched since our forefathers planted. They use only that naturally died and fell for different religious purposes like for smoking during Mass, church construction and the likes.
- Establishing and strengthening collaborative partnership with Ethiopian Orthodox Church, BOA, NGOs, GOs, local communities, administrative bodies and other respective partners for technical, financial, stewardship, managerial and administrative synergies and complementarities is necessary.
- Establish activities like implementing income-generating projects to make the local communities become direct beneficiaries from the church forest. Such a deed might trigger a motive and ownership feeling.
- Needs due attention and back up of policy makers in guarding and widening of EOC forest hold by their land administration policy
- Housing for religious ceremonies: there were open areas for communal meetings like Senbete, and the likes in Churchyards of Ayna Eyesus, Barkidane Mihret, and Nakuto Leab. Performing these things in houses could reduce forest depletion.

## I W&V T&I

Aalbaek, A. (1993). Seed Zone of Ethiopia and Eritrea. National Tree Seed Project, Addis Abeba.

Alemayehu, W. (2002). Opportunities, constraints and prospects of the Ethiopian Orthodox Tewahido Church in conserving forest resources: the case of churches in South Gonder, Northern Ethiopia. MSc thesis, ISSN 1402 – 201X (2002: 63), SLU, Sweden.

Azene Bekele Tessema. 1993. Useful Trees and Shrubs for Ethiopia: Identification, Propagation and Management for Agriculture and Pastoral Communities. Technical Handbook No. 5 RSCU/SIDA, Nairobi. World Agroforestry Center. 2002. Tree Databases CD-ROM. Nairobi.

- Dagnachew Gebeyehu, 2001. Sampling Strategy for Assessment of Woody Plant Species Diversity: A Study in Tara Gedam Natural Forest, Ethiopia. MSc thesis, Swedish University of Agricultural Sciences, Skinnskatterberg.
- Demel Teketay, 1997. Seedling population and regeneration of woody species in dry Afromontane forests of Ethiopia. *Forest Ecology and Management* 98 (1997), 149-165.
- Demel, T. (1997a). Seedling populations and regeneration of woody species in dry Afromontane forests of Ethiopia. *Forest Ecology and Management*, 98: 149-165.
- Edwards, S., Mesfin Tadesse and Hedberg, I. (eds.) (1995). *Flora of Ethiopia and Eritrea*, Vol. 2 (2). The National Herbarium Addis Abeba University, Addis Abeba and Department of Systematic Botany, Uppsala University, Uppsala.
- Edwards, S., Sebsebe Demissew and Hedberg, I. (eds.) (1997). *Flora of Ethiopia and Eritrea*, Vol. 6. The National Herbarium Addis Abeba University, Addis Abeba and Department of Systematic Botany, Uppsala University, Uppsala.
- Edwards, S., Mesfin Tadesse, Sebsebe Demissew and Hedberg, I. (eds.) (2000). *Flora of Ethiopia and Eritrea*, Vol. 2 (1). The National Herbarium Addis Abeba University, Addis Abeba and Department of Systematic Botany, Uppsala University, Uppsala.
- Feyera, S., Demel, T. and Nässlund, B.-Å. (2002). Native woody species regeneration in exotic tree plantations at Munessa-Shashemene Forest, southern Ethiopia. *New Forests*, 24: 131-145..
- Friis, I. 1992. *Forests and Forest Trees of Northeast Tropical Africa*. Kew Bull. Add. Ser. XV: 1-396.
- Hedberg, I. And Edwards, S. (eds.) (1989). *Flora of Ethiopia*, Vol. 3. The National Herbarium Addis Abeba University, Addis Abeba and Department of Systematic Botany, Uppsala University, Uppsala.
- Kebrom, T. (1998). *Ecological Rehabilitation of Degraded Hill Slopes in Southern Welo, Ethiopia*. PhD Dissertation, Uppsala University, Uppsala.
- Kebrom, T. & Tesfaye, B. (2000). The role of soil seed banks in the rehabilitation of degraded hill slopes in Southern Welo, Ethiopia. *Biotropica*, 32: 23-32.
- Lykke, A.M., (1998). Assessment of species composition change in savanna vegetation by means of woody plants' size class distributions and local information. *Biodiversity and Conservation* 7: 1261-1275.
- Mekuria, A., Demel, T. & Olsson, M. (1999). Soil seed flora, germination and regeneration pattern of woody species in an Acacia woodland of Rift Valley in Ethiopia. *Journal of Arid Environments*, 43: 411- 435.
- Sheil, D. and Agus Salim. (2004). Forest Tree Persistence, Elephants, and Stem Scars1. *BIOTROPICA* 36(4): 505–521
- Swaine, A.M., (1998). Assessment of species composition change in savannah vegetation by means of woody plants' size class distribution and local information. *Biodiversity and conservation* 7: 1261-1275.

- Tamrat, B. (1994). Studies on Remnant Afromontane Forests on the Central Plateau of Shewa, Ethiopia. PhD Dissertation, Uppsala University, Uppsala.
- Taye Bekele, 1998. Biodiversity Conservation: Experience of the Ethiopian Orthodox Tewahido Church, MSc in Forestry Graduates Magazine, 1994-1998.
- Tefera, M. (2001). The Role of Enclosures in the Recovery of Woody Vegetation in Degraded Hillsides of Biyo and Tiya, Central and Northern Ethiopia. MSc thesis, ISSN 1402 – 201X (2001: 54), SLU, Sweden.
- Tesfaye, B. (2000). Plant Population Dynamics of *Dodonaea angustifolia* and *Olea europaea* subsp. *cupidata* in dry Afromontane Forests of Ethiopia. PhD Dissertations, Uppsala University, Uppsala.
- Tesfaye, B. & Bengtsson K. (1999). Population structure of *Dodonaea angustifolia* and *Olea europaea* subsp. *cupidata* in Southern Welo, Ethiopia. Proceedings of the 11th Danish Sahel Workshop, 10: 99-105.
- Tesfaye, M. (2002). Environmental rehabilitation efforts in IFSP-Shire supported Woredas (Districts), lessons learnt and recommendations: Enclosures. In Demel Teketay & Yonas Yemshaw (Eds.), Proceedings of the Fourth Annual Conference of Forestry Society of Ethiopia, pp. 38-50, Addis Abeba: Forestry Society of Ethiopia..
- Yigardu Mulatu et.al. Potentials and Threats of Natural Forest Resource Base in Ethiopian Orthodox Tewahido Churchyards and Muslim Burial Grounds in Amhara Region. Unpublished.

Annex Table 1: Density and occurrence of species

<b>JaVIZa</b>	Density	No. of SGs of occurrence	No. of SPs of occurrence
<i>Kitkita</i>	6	154	17
<i>OSVYReZU</i>	L.	525	42
<i>Kechme</i>			175
<i>Weyra</i>	L.	303	129
<i>Atat</i>	(A. Rich.)		371
	Wilczek		31
<i>Embs</i>	Meikle	19	14
<i>Beles</i>			12
			5
<i>Tallo</i>	Olive.	11	14
	Hochst.ex	1	
	Benth.		
<i>Atana</i>		8	2
<i>Tsalwa</i>		20	11
			44
<i>Shefelda</i>		3	11
			1
<i>Egula</i>		3	2
<i>Arna</i>		1	23
			1
<i>Abika</i>		5	7
			2
<i>Ekma</i>		3	1
			1
<i>Bete musie</i>		1	2
			2
<i>Mita</i>			1
			3
<i>Ebrna</i>			
			1
<i>Angula</i>		4	
			1
<i>Amla</i>		2	
			1
<i>Lessa</i>			2
<i>Maloza</i>			2
<i>Tsiwa</i>		2	12
<i>Lomii</i>			2
<i>Dedeho</i>	(A. DC.) F.		10
	White		19
<i>Luciniya</i>		10	5
			1
<i>Morla</i>			
			1
<i>Milta</i>			1
			1
<i>Gba</i>			
			1
<i>Shesha</i>			
<i>Firtata</i>		2	
<i>Tigualmata</i>			
<i>Gita</i>		1	

Annex Table 1 (contd.):

<i>Degima</i>			2		
<i>Tulsa</i>			1		
<i>Warka</i>			1		
<i>Shola</i>			1		
<i>Kulqual</i>			24	14	1
<i>Agam</i>		(Forrk.)		27	24
<i>Temblel</i>	Vahl		1	44	5
<i>Msrosh</i>				6	6
		(Hochst)R.Br.ex.Vatke			
<i>Yesit kibat</i>				1	
<i>Koret</i>				5	5
	Decn.				
<i>Merez</i>			8	1272	3
<i>Segeg</i>			1		
			22	66	19
Dgta					2
<i>Smiza</i>				2	
<i>Nechlo</i>			1	3	
<i>Sola</i>				10	
<i>Simayteru</i>			2	1	
<i>Azamira</i>			1		
<i>Yetotakolet</i>			1		
<i>Akakma</i>				8	
<i>Feyelefeg</i>				3	
				1	
<i>Doret</i>			1	3	
<i>B`\'`SR</i>			1		
<i>Yewrawat</i>					1
<i>@^ RdeR</i>			1	2	1
<i>Dodota</i>			4	8	
			1003		



**Minale Wondie<sup>1</sup>, Yoseph Tewodres<sup>1</sup>, Ahunim Gedif<sup>1</sup>, Tadele Amare<sup>1</sup>, Gete Zeleke<sup>2</sup> and Enyew Adgo<sup>2</sup>**

<sup>1</sup>Adet Agricultural Research Center, P.O.Box: 08, Bahar Dar, Ethiopia  
<sup>2</sup> ARARI, P.O.Box 527, Bahir Dar

**Abstract**

The progressive reduction of the capacity of land to sustain the welfare of human beings is a common phenomenon in Amhara region in particular and in Ethiopia at large, due to serious deforestation and further land degradation. The objective of this study was to evaluate the efficiency of different water harvesting techniques to increase the survival rate of three tree seedlings both indigenous and exotic species; *Acacia saligna*, *Cordia africana* and *Croton machrostachyus* and to improve natural regeneration of degraded lands in Simada Wereda.

Three water harvesting structures namely, micro basin, eyebrow and trench were compared with the treatment without water harvesting structure (control) for better survival of tree seedlings. The treatments were arranged in RCBD with three replications. The area of each treatment data was 500m<sup>2</sup> (25x20m) and the spacing between treatments and replications were 2m and 5m respectively. Three fixed sampling plots (5m x 5m) in each large plots locating upper, middle and lower position with 5m spacing were used to determine regeneration of naturally existing trees, shrubs and grasses.

Data like survival rates, height and root collar diameter (RCB) of the tree species and the biomass of the natural regeneration under different water harvesting technique were recorded at different time intervals during the experimental periode of 39 months. According to the result of the experiment the seedlings growing on water harvesting structures performed much better than those grown without water harvesting structure. Among the three species tested, *Acacia saligna* had the best survival rates in all treatments while *Cordia africana* with a maximum survival rate of 11% under trench techniques was the least. *Acacia saligna* showed the highest survival rates (91%) under eyebrow water harvesting techniques. *Croton machrostachyus* took a middle position in its survival rates. Trench water harvesting techniques with 68% survival rates appeared to more suitable for *Croton* (68%). The maximum height and root collar diameter of *C. machrostachyus* was also observed under trench. Relatively, *C. Africana* also performed better on trench (11%) as compared to the other and its survival in the control treatment was nil. The natural regeneration of the closed area was also better under trench techniques.

Key words: water harvesting, seedling survival, natural regeneration, moisture deficit, simada

**Land degradation in arid, semi arid and highland areas of Ethiopia**

Land degradation in arid, semi arid and highland areas of Ethiopia is a serious problem and challenging to the livelihood of rural people and negatively affects the environment (Lakew Desta and et al, 2000; Volli, 2000). Land degradation is the progressive reduction of the capacity of the land to sustain life and provide food security (Volli, 2000). Soil erosion in Amhara in particular and in Ethiopia at large is a common problem mainly in highland areas of the region and soil erosion by water is the dominant form of erosion prevalent in Amhara region. The severely affected areas in Amhara region are Wag

Hemra and North Wollo followed by North and South Gondar, Eastern parts of South Wollo and Northern parts of North Shewa zones (Desta and et al, 2000)

Accelerated soil erosion is a combination of natural factors such as topography, erratic and erosive rainfall patterns and the action of man including the devastation of vegetation through deforestation, overgrazing and inappropriate agricultural practices which are in harmony with the environmental conditions (Betru Nedassa, 2002).

The major causes of land degradation include practicing of agriculture production on steep slopes and fragile soils without soil conservation and/or vegetative cover, erosive and erratic rainfall patterns, absence of fallowing, total dung and crop residue removal, deforestation and overgrazing. The accelerating forces to land degradation are population pressure, poverty, low access to agricultural inputs, low profitability of the agricultural sector, productivity fragmented land holding and insecure land tenure system (Lakew Desta and etal, 2000).

According to IIRR (2002), the natural resources in drought prone areas faced problems due to overgrazing, deforestation and soil erosion. On the other hand, different research works showed that moisture deficit and dry lands are surprisingly resilient. Because degraded, overgrazed lands still have a good room and capacity to recover.

Moisture deficit has direct implication for the survival of the people and great relationship with land degradation, food insecurity and poverty (IIRR, 2002). Therefore, it has an impact on social and environmental livelihoods.

Water stress is also the major growth limiting factor, which highly reduces the survival rate of tree seedlings in semi-arid areas of the Amhara Region. The rainfall in these areas is low in amount and erratic in nature. Occasionally, high-intensity rain produces high runoff and less soil water storage. This excess runoff could have been temporarily stored by creating artificial micro water storage basins around tree seedlings. Because of absence or inappropriate design of such structures or systems, tree seedlings suffer from moisture stress during most part of the year, mainly in the dry spells. Ultimately, most of the seedlings died after short time.

In moist deficit areas of Amhara region like in south Gondar especially in Simada, the area is marked with soil fertility depletion due to high and torrential rainfall with low vegetation cover. There is always unreliable and erratic rainfall in such areas of the region. The area is predominantly covered with acidic and have low inherent fertility. Continuous cropping, nutrient losses through harvest, soil erosion by rainfall and leaching result in natural degradation in general and the forest cover in particular. This severity has resulted in shortage of food for human beings and feed for animals and consequently, migration of the local people is increased.

Shrinking of land holding and declining of animal productivity with traditional farming practice has a contribution to natural resources base drying out. Off-farm activities in the area are limited investment in agricultural and other industrial practice is lacking so that unemployment is high in the area.

There are many different techniques practiced in drier parts of Africa adopted by farmers of which have given good results in experiment and are worth further trials (Muya, 1997). In Kenya different water harvesting techniques were used for moisture conservation in dry land areas of the country. Construction of water harvesting structures is an attempt to optimize the survival of tree seedling in drought prone areas. Since the most crucial and

limiting factor in drought affected areas is moisture for the survival and growth of plants and/or seedlings.

One of the recent approaches to overcome such problems in semi-arid areas is use of different water harvesting structures. This includes the methods able to increase water availability to plants such as rainfall multiplier systems and micro runoff storage mechanisms. Volli (2000) indicated that in Ethiopia, there is limited information and experience in Ethiopia on the potentials of water harvesting techniques and its possible uses. In most cases tree seedlings are planted without any water harvesting methods or using the common half-moon (micro-basin), which in most cases has not been constructed carefully following its design. Hence, the objective of this experiment was to evaluate efficiency of the different water harvesting techniques that can store rainfall and runoff water to increase survival rate of the tree seedlings in the semi-arid areas.

## **D R E V E R U D V E Y U**

The trial was established at the beginning of August 2001. The final inventory was taken in December 2004. Sites on hillsides with a slope of 20%, where their soils are not too rocky which has shallow depth were selected for the trial. Originally the area was stony and have scattered grasses dominated by herbs, and some were found in the area.

Three water-harvesting structures namely micro-basin, eyebrow, water collection trenches and control treatment were arranged in RCBD with three replications. Each plot was split into three for the three species used in the trial ( and

The construction of the techniques described by Volli Carucci (2000) was employed for the study. The dimension of the area for one treatment was 20mx25m (500m<sup>2</sup>) and the spacing between treatments and replications (blocks) was 2 and 5 meters, respectively.

Multi-purpose tree species for the area were selected as test plants. Each site was not fenced because there is shortage of locally available materials but was guarded to avoid interference of the free grazing and reduced stealing of grasses by the local people.

The structures were spaced 3mx4m (3m across the slope and 4m along the slope). The distance between two structures was measured from the center of the structure. Wider spacing was used with the density of 833 trees per hectare. Wider spacing is used because the area is moisture deficit so that to reduce moisture competition between seedlings planted in the area. The lateral distance between two consecutive structures was 50cm.

In this study a total of three species were used: one exotic species, and two indigenous species, and . These species were selected with preference of the local people. The number of seedlings per plot ranges from 37 to 56 and the number of seedlings per each species varied from 12 to 18 in each plot. Arrangement of species in each species was systematic. In each treatment the species has got different position in arrangement at each plot.

Three different water harvesting techniques, namely micro-basin (half-moon), eyebrow and trench were used as treatments and compared against control (without water harvesting).

Micro-basins are semi-circular structures made out of soil constructed along the contours for the main purpose of collecting and storing rainfall water to support the survival of plants in water deficit areas (Volli, 2000; IIRR, 2002). It can be used on gentle slopes to

collect runoff from smaller rainstorms for tree seedlings. They have small catchments with 2-4 meter across or the diameter of the structures. The lateral spacing between two half-moon structures is 50cm. And the spacing between the centers of two consecutive micro-basins was 3m. This spacing is measured from the center of the two consecutive micro-basins. The water collection ditch was 1mx1mx30cm deep and the volume of each water collection ditch ranged from 0.25m<sup>3</sup> to 0.30 m<sup>3</sup> (Volli, 2002) and the planting pit was dug on the lower position of the water collection ditch.

Eyebrow is semi-circular structure made out of stones constructed along the contours. They are suitable for shallow and stony soils of the dry areas due to their water harvesting effect. These structures can substitute replace micro-basins in low rainfall areas like Simada. It is constructed by digging a foundation of about 15-20cm deep and 20cm wide at the base and then decreased uphill. Large stones were placed in the center of the foundation. Water collection pit within the structure was dug 1m width x1m length and 25cm depth and the volume of each water collection ditch ranges from 0.25m<sup>3</sup> to 0.30 m<sup>3</sup> (Volli, 2000). The lateral spacing between two eyebrow structures was 50cm. And the spacing between two consecutive eyebrows was 3m.

Trenches are large and deep pits constructed along contours for the main objective of collecting and storing rainfall water, which are useful to the survival and growth of tree/shrub seedlings in dry areas and also can control erosion (Volli, 2000). They can and have a capacity to collect and store considerable amount of runoff water and/or soil. Each trench has a size of 2mx0.5mx0.25m to 0.3m. Therefore, each trench has got a capacity of collecting 0.25-0.30 m<sup>3</sup> soil and runoff in the area. After lay is out a contour line across the slope the soil was dug and the soil was piled up 25cm at the lower end of the trench. The dimension of the trench was 2m-lengthx50cm-width and then the planting pit was dug 20-30cm deep at the center of the structure. The soil dug was piled down the planting pit.

The control treatment without water harvesting is simple planting pit. The pit has 20-30cm depth and doubled diameter to the size of the pot i.e. 20cm to 30cm. No water harvesting structures were used but the arrangement of the planting pits was in a staggered arrangement as it has been done for the water harvesting techniques. The spacing between two planting pits was 3mx4m like the spacing arrangement of the structures. The area used for one seedling was 12 m<sup>2</sup>.

## **9 ccR\_XV^ V\_e` WYVh RvC YRcgVdeZ\_XeVIY\_Zbf Vd**

All the structures were arranged in a staggered arrangement on alternate rows so that the overflow from one row runs into the next row down slope. And the assumption was no water and soil loss exists with this arrangement. This is the common arrangement of water harvesting structures in the field condition for planting purpose of tree seedlings.

## **D WY Ud` WURRT ]jVieZ\_ R\_UdR^ a]Z\_X**

Baseline data of the site was collected at initial stage of the experiment supported with photograph documentation of each site. Experimental data was collected on average every six months starting from establishment. But the initial data was taken after three and half months. No beating up was taken after the establishment of the plantation.

Baseline data i.e. soil (soil depth, texture, pH, major physical and chemical characteristics, Available grass and tree/ shrub species, surface topography and photograph documentation. The area was staffed with scattered grasses and the soil depth was not more than 30cm.

Survival rate (SR) of tree seedlings, height, root collar diameter (RCD) were collected. The height and root collar diameters were measured using wooden tape and metallic caliper, respectively. Survival rate was measured in percent. Unit for measurement for height and RCD was in centimeters. For better precision, readings of two measurements were taken in a perpendicular direction of the standing seedlings. Data of maximum ten tree seedlings was taken for the aforementioned parameters. But for the survival measurement total count was taken. Ten seedlings were taken to take the parameters such as height and root collar diameter. This was done when the survived seedlings were above ten. If the number of survived seedlings were below ten, total counts were taken to measure the height and root collar diameter. But total count of survived seedlings was taken to compute the survival rate in percent for each species and comparison was made between the test tree species.

Data of maximum regenerated tree or shrub species under each treatment were recorded. Regeneration of natural existing trees, shrubs and grasses species (both type and abundance) was recorded using the following sampling method.

Three fixed sampling plots (5mx5m) in each plot were established. The sampling plots are located, upper, middle and lower position in each plot. Spacing between upper, middle and lower fixed sampling plots was 5 meters.

When the sampling plot location according to the measurement falls on the structures, we moved up or down or sideways so that it can be in between structures. The data measurement was not fixed but it is at the time where grasses and herbs start to dry and during the beginning of summer. Annually, the grass biomass was harvested (cut at about 15 cm heights) from each fixed plot and weighed. As part of the experiment the total grass biomass was harvested, weighed, piled and distributed among farmers. The cost of the grass/herb biomass was estimated depending on the existing and current cost to estimate the benefits gained from the trial.

## **1.5 Results and Discussion**

### **1.5.1 Survival rate of tree species in different water harvesting structures**

The survival rate of the different tree species in different water harvesting structures is presented in Table 1. The different species differ in their survival rates with the same water harvesting techniques. *Acacia saligna* was superior in its survival rates (up to 91%) followed by *Croton*

The impact of the different water harvesting techniques on the survival of seedlings was significant as shown in the table. *Cordia Africana* seedlings failed to survive in eyebrow and micro-basin structures as that of without water harvesting measures, while *Croton* failed completely in the treatment without water harvesting. As it is observed in the field the species dried from top to down i.e. a sort of die back was observed and due to moisture deficit seedlings wilted and looked unhealthy as compared to in other treatments. The survival rate of *Croton* in micro-basin and eyebrow was 48% and 35% respectively which was much better than the control but still below 50%. It appeared to survive better in trench

water harvesting techniques (62%) while the same water harvesting structure was helped to survive only 11% of the Cordia seedlings at the end of the 39 months age.

Table 1: Effects of different water harvesting techniques on survival rates (%) of *A. saligna* and *Cordia africana* at Simada

Age in months	<i>A. saligna</i>				<i>Cordia africana</i>				Survival rate (%)			
	Control	Micro-basin	Eye-brow	Trench	Control	Micro-basin	Eye-brow	Trench	Control	Micro-basin	Eye-brow	Trench
3.5	26.0	76.0	58.0	70.0	45.0	51.0	36.0	53.0	86.0	91.0	97.0	73.0
8.5	35.0	62.0	58.0	70.0	17.0	38.0	35.0	51.0	78.0	91.0	98.0	71.0
15.5	3.0	52.0	46.0	62.0	7.0	22.0	26.0	40.0	75.0	89.0	92.0	70.0
23	3.0	47.0	43.7	65.0	2.0	14.0	18.0	18.0	54.3	81.0	92.0	62.0
30	2.7	47.0	35.0	62.3	2.0	2.3	0.0	10.7	54.3	77.3	92.0	62.0
35	0.0	48.3	35.0	62.7	1.7	2.3	0.0	10.7	28.3	77.7	90.7	62.0
39	0.0	48.3	35.0	62.3	1.7	2.3	0.0	10.7	28.3	77.7	90.7	62.0

*A. saligna* showed a survival rate of 78% at the age of 39 months in micro-basin. Eyebrow technique was superior, about 91% for the survival of *A. saligna* seedlings at the end of the experiment to all the tested water harvesting structures. The survival rate increment helps to increase the density of the species per unit area and the plantation remained almost the same as it was planted. Surprisingly, *A. saligna* performs poorer in trench than in micro-basin and eyebrow structures. The survival rate was only 62% at the end of the experiment. Perhaps, *A. saligna* is sensitive to more moisture than the other species which have showed the opposite trends. Its survival without water harvesting, was 28% at the end of the experiment which was much better than the survival rates of *Cordia* in all the tested water harvesting techniques.

Table 2 shows the influence of different water harvesting structures on plant height for the three tree species.

Table 2: Effects of different water harvesting techniques on plant height of *Cordia africana* and *Acacia saligna* at Simada

Age in months	<i>Croton</i>				<i>Cordia</i>				<i>A. Saligma</i>			
	Control	Micro-basin	Eye-brow	Trench	Control	Micro-basin	Eye-brow	Trench	Control	Micro-basin	Eye-brow	Trench
3.5	8.7	11.6	12.7	10.5	9.4	8.5	8.8	22.3	27.9	31.5	31.6	37.0
8.5	8.6	11.1	11.0	9.9	11.7	8.3	7.4	16.1	16.4	25.7	21.5	34.0
15.5	2.7	17.7	20.2	25.6	11.8	15.4	12.8	25.9	39.6	70.8	80.3	95.7
23	2.7	21.0	18.5	29.5	11.3	22.0	14.2	25.0	44.8	101.9	112.7	92.2
30	0.0	24.7	26.7	38.1	11.3	16.7	0.0	12.7	84.4	148.9	136.9	116.7
35	3.3	23.9	26.3	34.3	2.7	18.7	0.0	18.5	110.5	136.7	123.4	118.0
39	0.0	27.6	31.7	39.1	15.0	17.7	0.0	19.0	141.2	180.2	136.7	128.5

Each species attained similar plant height at the end of the 39 months age. The different in plant growth seems to be highly dependent on the species type rather than the water harvesting techniques.

A. Saligna reached a maximum height of 180 cm at the end of 39 months experimental period which is equivalent to an annual growth of nearly 50 cm. Cordia africana achieved only 19 cm height after 3 years with an annual growth rate of 3.6 cm while Croton was better in growth than Cordia (annual growth rate of 6.3 cm).

Generally the impact of the different water harvesting structures on plant growth seems to be insignificant. Once seedlings are well established its growth is entirely affected by the tree species. Treatments that led to high survival rate of the respective species didn't necessarily influence plant growth.

The influence of water harvesting techniques on root collar diameter (RCD) is shown in Table 3. RCD followed the some trend as plant height for the different tree species. A. Saligna achieved RCD of 3.5-5. 8 cm while Cordia reached only a maximum of 1.5 cm. Croton with RCD of 1.6-2.2 took middle position. For croton and cordial, one can say that treatments with better survival rate showed better plant growth and RCD while this generalization can't apply for the A. Saligna.

Table 3: Effects of different water harvesting techniques on root collar diameter (RCD) of Cordia africana and Acacia saligna at Simada

Age in months	; c` e` _				; ` cUR				9 *JRZ^ R			
	; ` _ec` ]	D Zic` )	=j V)	KeV_TY	; ` _ec` ]	D Zic` )	=j V)	KeV_TY	; ` _ec` ]	D Zic` )	=j V)	KeV_TY
3.5	0.4	0.5	0.5	0.5								

/ 25 \* ; ; 8:7- =, 276

The regeneration status of the closed area was also measured at 15.5 and 30 months time interval which is given in Tables 4, 5, 6, 7 and 8. Field observations showed that the originally bare land recovered after 15.5 months of area closure. Grasses and herbs regenerated and invaded the area, which are used as a feed for animals during peak periods of dry seasons. Farmers were also able to get additional income through sells of grasses. The soil seed bank was obviously contributed for the fast regeneration of the area. The regeneration of new grasses and/or herbs species increased the biodiversity of the area. The coverage of invading species increased year after year as long as the area was protected from any animal and human interference.

Moreover, the structures collected runoff and soil sediment within the dug out pits. The structures stabilize the area through supporting the land from being eroded and loss of moisture.

Table 46 Regenerated Species on Micro-basin

At the age of 15.5 months				At the age of 30 months			
Tree/ Shrub	No	Grasses/ Herbs	Grasses/ Herbs	Tree/ Shrub	No	Grasses/ Herbs	Grasses/ Herbs
Alashume	28	Chifrig	Kesie	Girar	2	Murie	Chifrig
Girar	1	Yediha akomada	Yetota kolet	Kitkita	6	Gaja	Akirima
Kitkita	4	Enshilalit	Murie	Alashume	4	Yezinjero fes	Yewusha milas
Embacho	1	Senkelo	Gaja	Embacho	1	Yemeret wesfat	Kesie
Metete	25	Akirima	Yewef teff	Atat	1	Sirsira	Kotetina
		Tosign	Lambut	Duaduatie	11	Anterifa	
		Machid seber	Yetota Murie	Kega	1		<b>JYV<sup>a</sup> XXXZ</b>
		Senbelet	Chigogot				
		Wajima	Kotetina				
		Yemidir	Yetef				
		embuay	akomada				
		Yebeg lat	Gorteb				
		Serdo	Nech arem				
		Ret	Sirsira				

About five tree/shrub species were regenerated at the age of 15.5 months and more than 26 grass/herb species have been identified which are listed in Table 4 with their local names.

More grasses and herbs have invaded the micro-basin immediately after the construction. But gradually at the age of 30 months, after establishment of the structures the number of tree/shrub species increased by one i.e. 7 species but individual number per each species decreased. But the number of grass/herb species decreased from 27 to 13 after 2.5 years.

As indicated on the Table 4 at the age of 15.5 months time, trees/shrubs were newly emerged and invaded the area. About 24 locally known grasses and herbs and 5 trees/shrubs regenerated and invaded the area. Farmers took the grass using cut-and-carry system. But they mowed without selecting the regenerated species. This has been done during drier seasons of the area when there is shortage of feed for their cattle.



All pioneer as well as newly emerged species invading the area have been uprooted and given to their cattle. With the same trend of the micro-basin at the age of 30 months the area was grazed without the permission of the guard. And hence, the initial tree/shrub species regenerated missed and another four tree/shrub species regenerated. The grass/herb species also reduced from 24 grass/herb species known before to 16 in number.

Table 5: Regenerated Spaces on eyebrow

At the age of 15.5 months				At the age of 30 months			
Tree/ Shrub	No	Grasses/ Herbs	Grasses/ Herbs	Tree/ shrub	No	Grasses/ herbs	Grasses/ herbs
Alashume	22	Chifrig	Yeshiwuta- medihanit	Agam	1	Yemidir embuay	Yezinjero fes
Kitkita	6	Yewef teff	Gaja	Atat	1	Chifrig	Murie
Girar	2	Maget	Serdo	Kega	1	Gaja	Birbir sar
Embacho	1	Yeberie kolet	Yeferes zeng	alashume	1	Yewef teff	Yemeret- wosifat
Metete	7	Kotetina	Kesie			Gorteb	Ret
		Senbelet	Yebet sar			Akirima	Gejeme
		Yetota kolet	Bunign			Sirsira	Senkelo sar
		Senkelo	Wajima			Serdo	Kotetina
		Yebeg lat	Akirima				
		Murie	Anteref				
		Adey abeba	Amerarie				
		Nech arem					

Water collection trench encouraged regeneration 7-tree/shrub specie and 18 grass/herb species and were identified with their local name and recorded within 15.5 months after establishment of the trial. But after 30 months, the number of tree/shrub species and grass/herb specie decreased from 7 to 5 and 18 to 13 respectively. The reason was the local people left their cattle to graze by refusing the guard.

Table 6: Regenerated species on water collection trench

At the age of 15.5 months				At the age of 30 months			
Tree/ Shrub	No	Grasses/ herbs	Grasses/ Herbs	Tree/ Shrub	No	Grasses/ herbs	Grasses/ herbs
Alashume	50	Kesie	Gaja	Embacho	6	Gaja	Wariat
Lute	1	Chifrig	Wariat	Alashume	2	Goriteb	Kesie
Meteto	3	Gicha	Serdo	Weyira	1	Gume	Kotetina
Yewusha- milas	1	Akirima	Yebeg lat	Girar	3	Keskeso	Yezinjero fes
Metetie	16	Mrie	Kutetina	Kitkita	5	Chifrig	Murie
Kitkita	3	Yetota kolet	Senbelet			Wariyat	Senbelet
Atat	1	Lambut	Goriteb			Ret	
		Nech sar	Tosign				
		Yezinjero- kimem	wajima				

On the treatment control (without water harvesting techniques), some five tree/shrub species and 21 grass/herb species regenerated during one and quarter year. Since the area

was not well protected by the guard, the number of species regenerated and invading the area decreased as time goes up. Hence, at the age of two and half years the number of grass/shrub species decreased from 21 to 14. Some of the tree/shrubs disappeared and another new species (which were not present at the age of 15.5 months) regenerated. For example, Kitkita and Embacho newly regenerated, but Metetie and Yezinjero kimem disappeared after one and quarter years after emerging in the area.

Table 7: Regenerated Species on control

At the age of 15.5 months				At the age of 30 months			
Tree/ Shrub	No	Grasses/ herbs	Grasses/ herbs	Tree/ Shrub	No	Grasses/ herbs	Grasses/ herbs

Table 8: Comparison of economic benefits from different water harvesting structures

Treatments	At the age of 15.5 months			At the age of 30 months		
	Biomass (kg/ 25 m <sup>2</sup> )	Biomass (kg/ha)	Estimated income gained (Birr/ha)	Biomass (kg/ 25 m <sup>2</sup> )	Biomass (kg/ha)	Estimated income gained (Birr/ha)
Micro-basin	1.5	600	90 <sup>aa</sup>	1.18	472	94.40 <sup>bb</sup>
Eyebrow	1.77	708	106.2 <sup>a</sup>	1.31	524	104.80 <sup>b</sup>
Trench	2.17	868	130.2 <sup>a</sup>	1.86	744	148.80 <sup>b</sup>
Control	0.83	332	49.8 <sup>a</sup>	1.32	528	105.60 <sup>b</sup>

The water harvesting structures constructed in these degraded lands conserved soil and water and keeps the area from loss of nutrients. The conservation of water with the help of water harvesting techniques increased the vegetation cover of the area. The biodiversity increased from year to year in kind and amount. Especially the plants like herbs and grasses increased.

The structures were filled with woody species existing in soil seed bank regenerate and started to invade the land found above the micro-catchment. Therefore water-harvesting structures for water deficit areas has a potential to reduce erosion and runoff on degraded areas like Simada so that increased the existence of different species.

From the results of the experiment, it is possible to conclude that developing water harvesting structures for the growth of important tree crops is the best option for the survival and growth parameters of seedlings in drought affected and moisture deficit areas, such as Simada and the like.

From the results of the experiment it is possible to recommend the following:

Water harvesting structures could increase the survival rates of seedlings in drought prone areas. Survival rate of seedlings appeared to be also species dependent. Growing

is best for moisture deficit areas and its survival rates can be improved by three folds (91%) using water harvesting structures like eyebrow. Though there are quite huge differences among them, performed better under trech techniques with survival rates of 62% and 11% respectively Croton didn't survive at all without water harvesting measures. Degraded hills recovered through area closure and more rapidly in combination with water harvesting activities. Water harvesting structures can also retard erosion in addition to conserving moisture. The over all result showed that the performance of all species under treatment without water harvesting structure was very low in all parameters used in the experiment. Hence, developing water harvesting structure for the growth of important tree crops and for natural regeneration is the better option for the survival and growth of seedlings in drought affected and moisture deficit areas.

## **I W&V IV**

- Betru Nedassa. 2002. Soil and Water Conservation Program in the Amhara National Regional State. WFP National Coordinator, Ministry of Agriculture. Addis Ababa, Ethiopia.
- Carucci Volli. 2000. Guidelines on water harvesting and soil conservation for moisture deficit areas in Ethiopia: The productive use of water and soil. Manual for trainers, first draft Addis Ababa, Ethiopia
- Lakew Desta, Menale Kassie, S.Benin and J.Pender. 2000. Land degradation and strategies for sustainable development in the Ethiopian highlands: Amhara Region. International Livestock Research Institute. Amhara National Regional State Bureau of Agriculture, Working paper No. 32.
- Anonymous. 2003. Proceedings of the conference on: Natural Resource Degradation and Environmental Concerns in Amhara National Regional State, Impact on Food Security, Bahar Dar, Ethiopia.

## **9 XcZf Jcf cRj D VIYR ZkReZ \_**

**D`UZMReZ\_R UVgRjf ReZ\_`W? ). , , , ^ f JcZ Te` a eYcVdYVc**

Worku Biweta, Mulugeta Agegnehu, Tadele Tafesse,

Nuru Mohammed and Dilinesa Ewunetu

Combolcha Agricultural Mechanization Research Centre

P.o.Box 146 ,Combolcha

### **9 SdecRle**

Thresher is a machine that helps to separate grains from the harvested crop and provide clean grain without much loss and damage. During threshing grain loss in terms of broken grain, unthreshed grain blown grain, spilled grain etc, should be minimal. Therefore, this study is aimed to modify SG-2000 multi-crop thresher with cleaning mechanism. The thresher was evaluated for its performance in terms of threshing efficiency, cleaning efficiency, visible damage and sieve overflow. Results of the study indicated that the thresher work best with drum speed (900, 1000, 600, 400 rpm), feed rate (8, 10, 14, 15 kg/min) at which the thresher capacity was measured to be (130, 126, 194, 636, 665 kg/hr) for wheat, barely, teff, sorghum and maize respectively. The cleaning efficiency is not sufficient, so there must be supplementary manual blowing.

### **A ec` UF TeZ \_**

Indigenous threshing technology practised by farmers in Ethiopia is mainly done by the use of animal treading and beating by stick on level ground, which is time and labour consuming and involve drudgery. After harvesting, the crop is transported to the threshing site where it is left stacked till the threshing season, which is usually November, December and January. The threshing floor is usually made by smearing the ground with cow dung and left to dry for some time otherwise the ground after being levelled will be watered and trampled by foot according to the type of crop, which is going to be threshed. During threshing, the loose crop is laid on the floor and several oxen tread on it. The oxen go round on the threshing floor over the crop for some time and they are taken out to turn the unthreshed crop from the bottom up and down to spread it laying the heads up for efficient treading. The threshed crop is subjected to winnowing by natural wind flow.

Threshing with animals need both skill and energy to keep the animal moving around the threshing floor. The threshing season normally lasts 2-3 months, but with the increased in production and shortage of labour power threshing may not be completed with this time. The delay on completion of the threshing operation within safe time will expose the crop to unfavourable weather and will result in quality deterioration, insect and rodent attack. Therefore, this method of threshing method gives low quality grain and high percentage of loss.

Past thresher development experience in Ethiopia indicate that the Chilalo Agricultural development unit (CADU) tested different threshers. Test result of the animal drawn trade multi-type thresher revealed that the thresher was found inefficient because of its low peripheral velocity (17.5m/s) and the difficulty of keeping a uniform speed. It is difficult to move the thresher from place to place since it is stationary model. Lastly

CADU designed a wooden type cleaning thresher. Later on it was found that the change in dimension of wooden part made interchangeability difficult and was costly.

The Arusi Rural Development project (ARDP) developed 8 hp diesel engine driven and non-cleaning type wheat barely thresher. Except its seed breakage problem this thresher was found to be good. The Institute of Agricultural Research (IAR) took over it and improved the concave assembly and reduces the breakage to 21 % for wheat and 4.5% for barely. This machine is suitable only for wheat and barely where its limited annual use hours make it expensive (Firew.K, Muluken.T Awotahegn.T, 1994).

The existing method does not encourage high output and often result in low quality products. However, there is a growing need of providing the farmer with an appropriate thresher. In the past years, some stakeholders and research centres tried to develop mechanical threshers to minimize these shortcomings. Among different attempts, Sasakawa Global 2000 has recently developed multi crop thresher with its model name SG-2000 multi crop thresher.

### DESCRIPTION OF THE MACHINE

The SG-2000 multi-crop thresher was primarily designed for threshing pulse crops without winnowing the chaff from the grain (Figure 1). The thresher is driven by 5 hp diesel engine and operates on the principle of axial flow movement of material. Threshing is done by the impact of a cylindrical drum equipped with a number of spikes mounted on its periphery and concave. The upper cover has inclined louvers, which move the threshing material axially between the threshing drum and the cover.

SG-2000 multi-crop thresher was primarily designed for threshing pulse crops without winnowing the chaff from the grain (Figure 1). The thresher is driven by 5 hp diesel engine and operates on the principle of axial flow movement of material. Threshing is done by the impact of a cylindrical drum equipped with a number of spikes mounted on its periphery and concave. The upper cover has inclined louvers, which move the threshing material axially between the threshing drum and the cover.

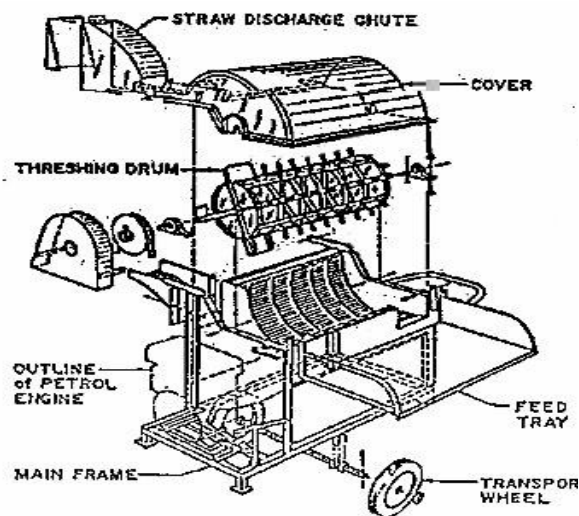

Figure 1: SG-2000 multi-crop thresher

The material is loaded on the feeding table and feed into the opening between the cylinder and lower concave. The crop is brushed in to fine straw, which results in good animal feed. The majority of the grain is threshed during the initial impact, but further threshing is performed while the material moves axially to the straw outlet. Finally the straw is discharged through the outlet by the straw paddle. The maximum threshing

capacity of the machine is 3.9q/h. It requires 14 man hours to clean 100kg of grain from the chaff and straw.

During testing of the thresher, the following demerits and merits were observed respectively.

< V^ VcZd

- The engine is exposed to fire hazardous due to overheating.
- Frequent clogging of engine air cleaner is observed due to chaff and straw.
- Inconvenient construction of concave hole for different crops, hence unthreshed ear and straw pass through it.
- Construction of grain and straw outlet in one side (direction) caused mix-up of grain mixture and straw.
- Feeding is uncomfortable since the thresher height is short.
- Extra length of feeding table at the right side with the edge of the inlet hole caused breakage of ears.
- Without cleaning mechanism, it is tedious, time and labours consuming to separate grain from chuff.

Merits

- The thresher is simple for production, transportation, operation and easy for maintenance and repair.
- The cost of this thresher is cheap compared to other types of threshers.
- Farmers can operate the machine within a short period of training (Test report 1992 E.C. Combolcha).

Taking the above demerits in to consideration, the following modifications were done during manufacturing.

- ❖ Suitable guard is installed to protect the engine for fire hazard.
- ❖ While constructing the concave, the space between the round bars is made to be 5mm, this decreases unthreshed ear and straw passing through the concave opening.
- ❖ Clean grain is discharged to the side of the thresher using discharge auger, while the straw and chaff blows out of the thresher.
- ❖ Height of the feeding table is increased by 15 cm to make comfortable for the operator during feeding.
- ❖ Length of the feeding table is made to fit equally to inlet hole edge at the right side.

The total power required for driving the thresher is 7.1 KW. Therefore, the total power required for main component and transmission loss is calculated to be 8 KW. Based on this ADN-43 diesel engine is recommended (Bosoi.E.S, O.V.Verniaev, 1991).

A centrifugal blower consists of four fan blades mounted on a shaft supported by ball bearing and housing which is used to deliver the specified volume of air to separate light particle mounted underneath the concave. The air inlet of the centrifugal blower casing is located at 90 degrees to the outlet (Figure 2). Air enters the centre of the rotating blower impeller parallel to the impeller shaft and turned through 90 degrees by

the impeller before being discharged. Too much draught blows the grain out of the block; while too little fails to keep the screen clear (Figure 3).

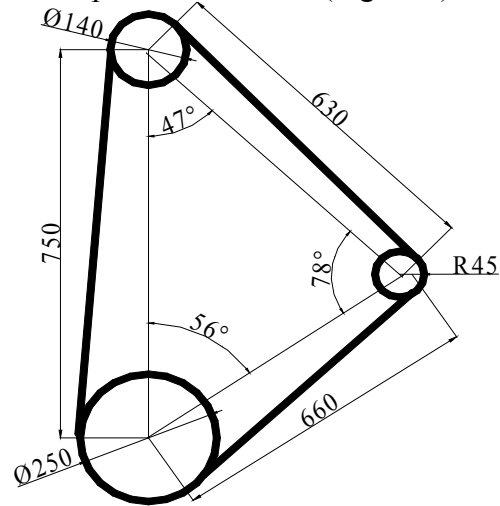

Figure 2: Power transmission

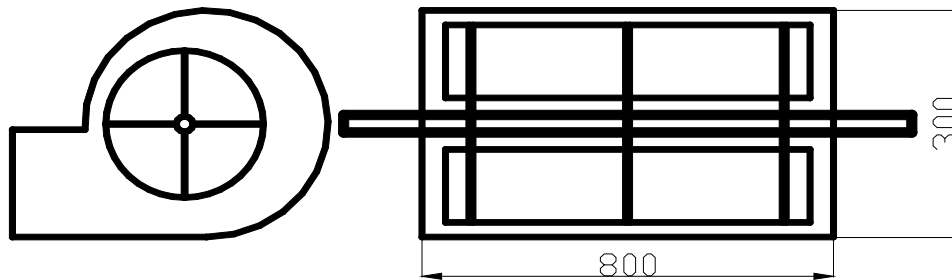
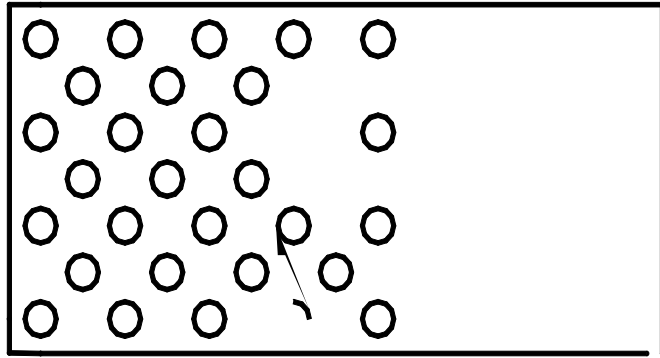

Figure 3: Blower assembly

The sieve helps for further cleaning of the grain by allowing heavier straw to overflow. When solid particles are dropped over a screen, the particles smaller than the size of the screen-opening pass through it, and large particles greater than the size of the screen opening retained over the screen (Figure 4).





The portion of the material that contain unthreshed grain was separated from straw and weighed after hand threshing and cleaning in order to determine the threshing efficiency in terms of percentage of the total grain recovered. Determination of optimal input capacity and selection of the feed rate to improve the efficiency are within the specified limits. This was achieved by drawing a curve for efficiencies versus feed rates. Instruments used for the tests include tachometer, sensitive balance, spring balance and oven dry.

### I. The Effect of Feed Rate and Speed on the Performance of Multi-Crop Thresher on Wheat

#### 1.1. Effect of Feed Rate and Speed on the Performance of Multi-Crop Thresher on Wheat

During testing of multi-crop thresher on wheat, three levels of feed rate (10, 9, 8 kg/min) and three level of speed (800, 900, 1000 rpm) were taken for the study. The best combination is selected by drawing three graphs, but the graph for threshing efficiency is omitted because the difference between the treatments is insignificant. The test result shows that cleaning efficiency increases as the feed rate and speed increases up to a certain limit and then finally it decrease. The visible grain damage increases as speed increases and feed rate decreases, and sieve overflow also increases, as speed and feed rate increases because the material handled by the sieve is more than the sieve capacity (Table 1 and Figures 6, 7 and 8).

Table 1: Performance of thresher on threshing of Wheat

Speed (rpm)	Feed Rate (kg/min)	Grain Recovered (%)	Grain Damaged (%)	Grain Broken (%)	Sieve Overflow (%)	Grain Yield (kg)
800	10	85	15	5	10	100
800	9	85	15	5	10	90
800	8	85	15	5	10	80
900	10	85	15	5	10	100
900	9	85	15	5	10	90
900	8	85	15	5	10	80
1000	10	85	15	5	10	100
1000	9	85	15	5	10	90
1000	8	85	15	5	10	80

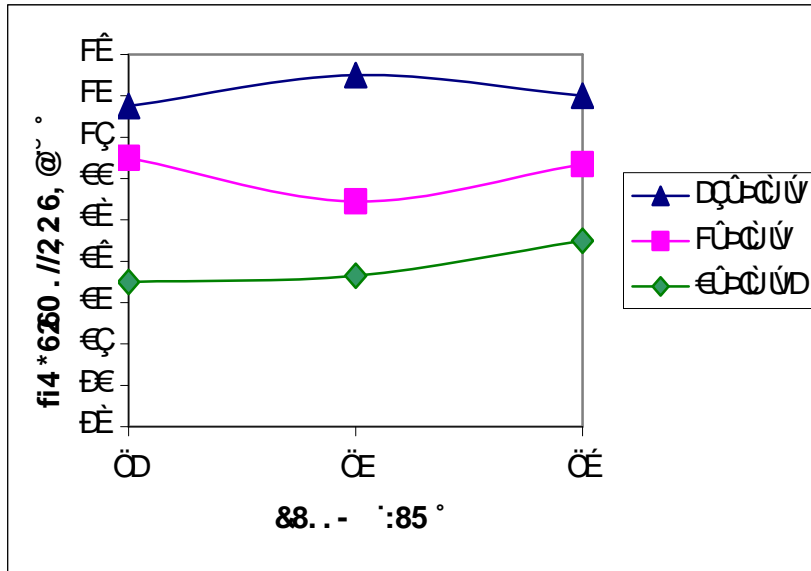

Figure 6: Effect of speed and feed rate on cleaning efficiency of wheat

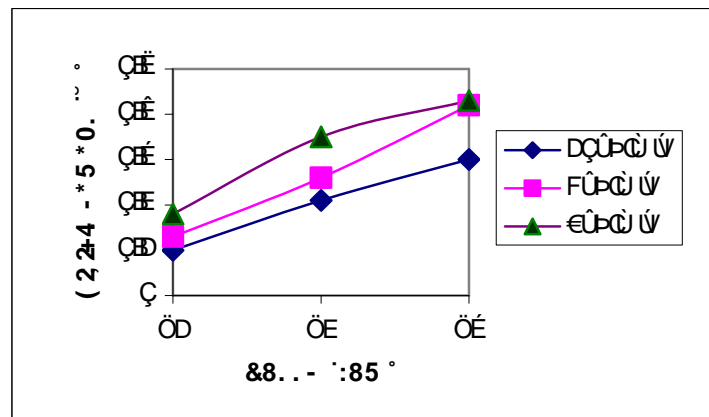

Figure 7: Effect of speed and feed rate on visible damage of wheat

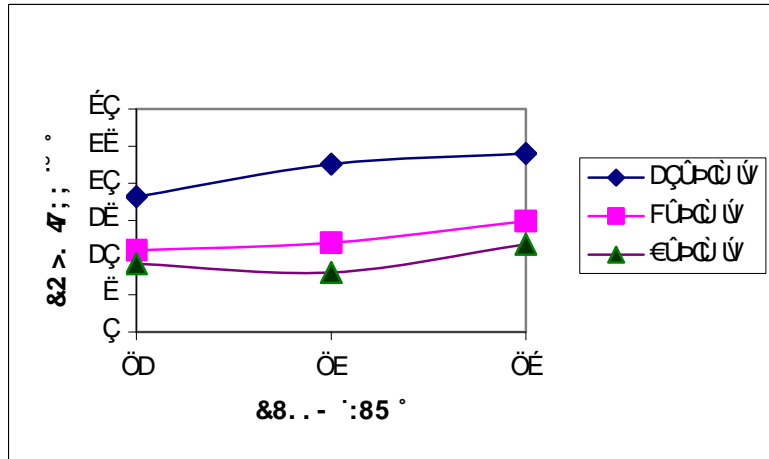

Figure 8: Effect of speed and feed rate on sieve loss of wheat

### Multi-crop thresher on barely

During testing of multi-crop thresher on barely, three levels of feed rate (10, 9, 8 kg/min) and three level of speed (800, 900, 1000 rpm) were taken for the study. The best combination is selected by drawing three graphs, but the graph for visible grain damage is omitted because the difference between the treatments is insignificant. The test result shows that threshing efficiency increases as the speed and feed rate increases. This is because at a higher speed the energy imparted to the ear head and grain increases causing higher threshing efficiency. Cleaning efficiency increases as feed rate and drum speed increase up to certain limit and decrease again, and the sieve overflow increase as the speed and feed rate increase (Table 2 and Figures 9, 10 and 11).

Table 2. Performance of thresher on threshing of barely.

Drum Speed (rpm)	Feed Rate (kg/min)	Threshing Efficiency (%)	Cleaning Efficiency (%)	Sieve Overflow (%)
800	10	85	65	55
900	9	88	68	52
1000	8	90	72	60

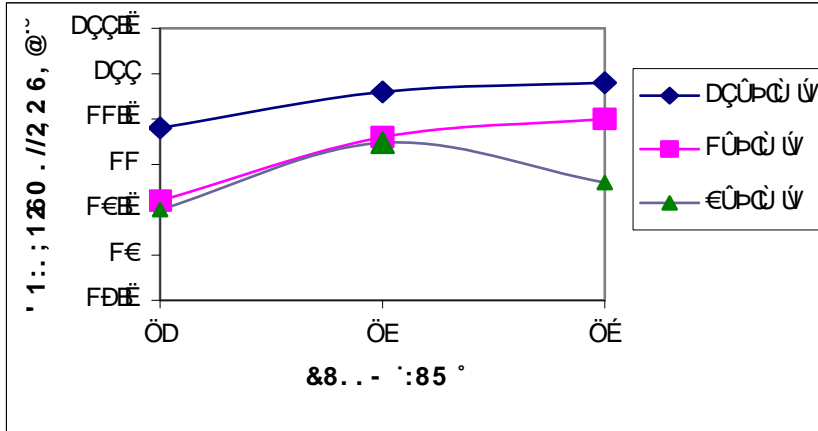
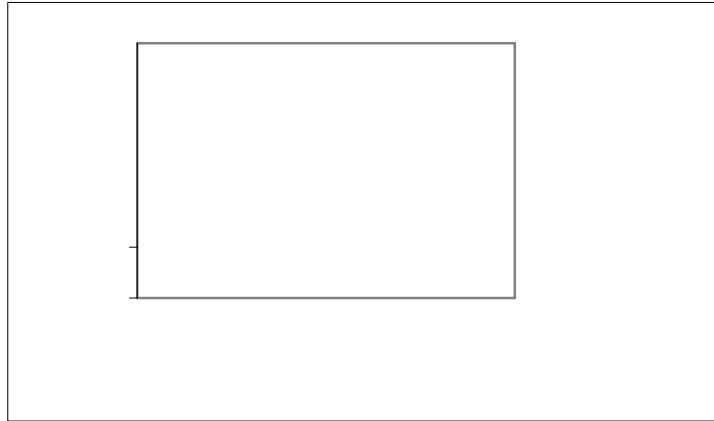

Figure 9: Effect of speed and feed rate on threshing efficiency of barley



### KVde cVf je` \_ eVW

During testing of multi-crop thresher on , three levels of feed rate (8, 10, 12 kg/min) and three level of speed (800, 900, 1000 rpm) were taken for the study. The best combination is selected by drawing two graphs, but threshing efficiency and visible grain damage are omitted, because the difference between treatments is insignificant. Cleaning efficiency increases as the speed increases and feed rate decreases. Also sieve over flow increases as speed and feed rate increases, because the sieve begin bulged. Since cleaning efficiency is not sufficient, manual blowing by natural wind is essential (Table 3 and Figures 12 and 13).

Table 3: Performance of thresher on threshing of

NW	OSPZJ SVZD	RSPVWP ŠTUBŠVR' Æ	Ol\$as ÜWY
D I DAODAMODA		€E	EE
E I DAOEAMOE A		€FB	EEBE
E I DAOEAMOE A		FDEE	EDBF
E I EAODAMOE A		€ED	EE
E I EAOEAMOE A		FEEE	ED
E I EAOEAMOE A		FE	EFBF
E I EAODAMOE A		FDBF	EE
€ I EAOEAMOE A		FE	ED
F I EAOEAMOE A		FEEE	EE

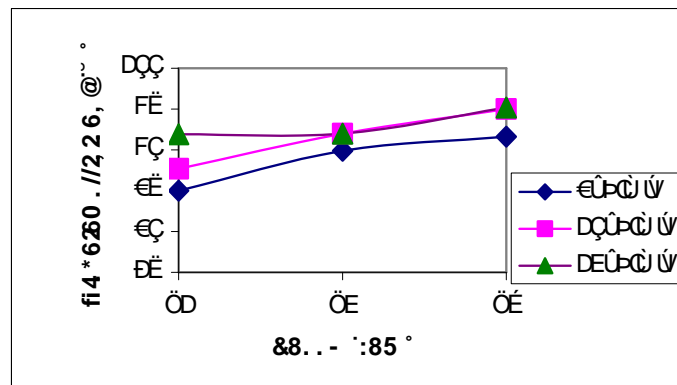

Figure 12: Effect of speed and feed rate on cleaning efficiency of

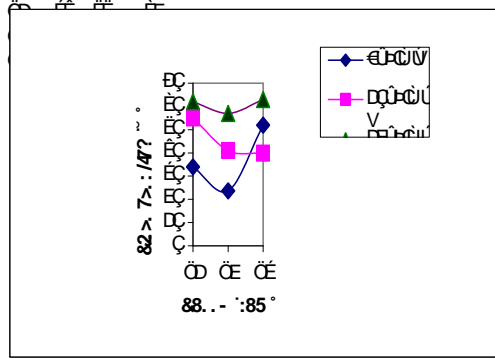

Figure 13: Effect of speed and feed rate on sieve overflow of

**Performance of multi-crop thresher on sorghum**

During testing of multi-crop thresher on sorghum, three levels of feed rate (10, 12 and 14 kg/min) and three level of speed (600, 700 and 800 rpm) were taken for the study. The best combination is selected by drawing four graphs. The test result shows that threshing efficiency increases with increase cylinder speed for all feed rate, where cleaning efficiency increases as feed rate decreases and speed increases. Visible grain damage increases as the speed increases and feed rate decreases where as sieve overflow increases as speed and feed rate increases (Table 4 and Figures 14, 15, 16 and 17).

Table 4: Performance of thresher on threshing of sorghum

No.	Speed (rpm)	Threshing efficiency (%)		Cleaning efficiency (%)		Sieve overflow (%)
		10 kg/min	12 kg/min	10 kg/min	12 kg/min	
1	600	85	80	95	90	15
2	700	90	85	98	95	25
3	800	95	90	100	98	35
4	600	80	75	90	85	55
5	700	85	80	95	90	65
6	800	90	85	100	95	75
7	600	75	70	85	80	85
8	700	80	75	90	85	95
9	800	85	80	95	90	105

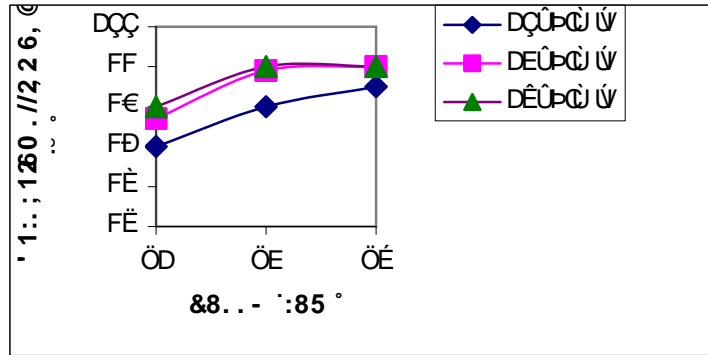

Figure 14: Effect of speed and feed rate on threshing efficiency of sorghum

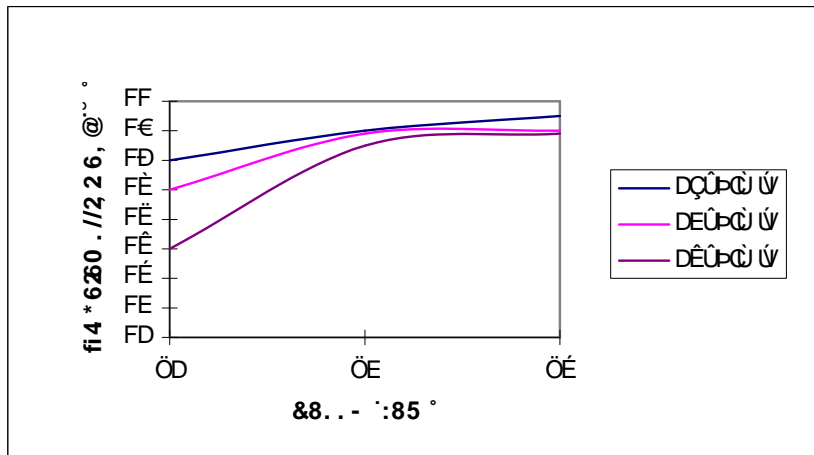

Figure 15: Effect of speed and feed rate on cleaning efficiency of sorghum

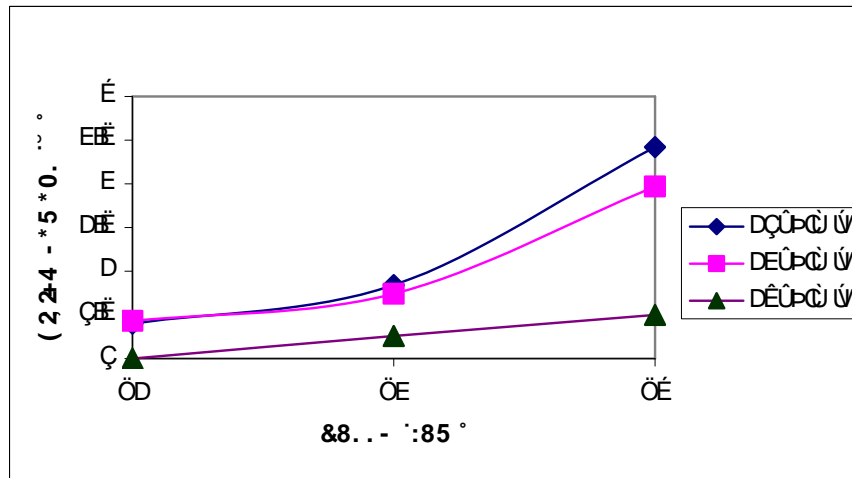

Figure 16: Effect of speed and feed rate on visible damage of sorghum



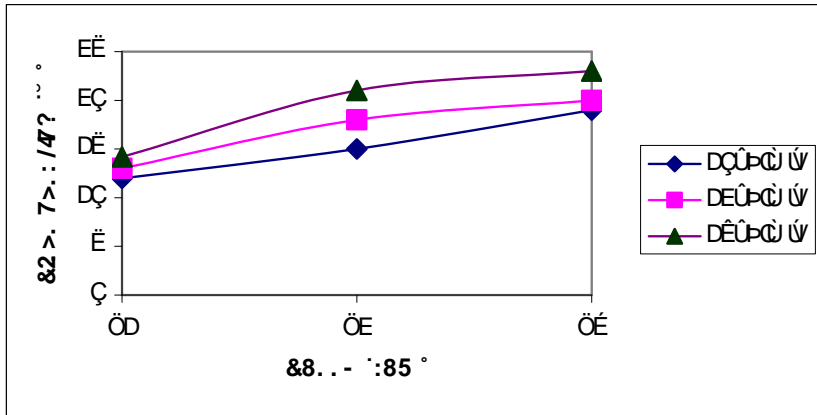

Figure 17: Effect of speed and feed rate on sieve overflow of sorghum

### KVde cVf je` \_ ^ RZV

During testing of multi-crop thresher on maize, two levels of feed rate (15 and 20 kg/min) and three level of speed (350, 400 and 450 rpm) were taken. For maize shelling fingers which are used for cutting straw are disassembled in order to avoid grain breakage. The test result shows that shelling efficiency increases with speed and feed rate increases and cleaning efficiency increases with speed increases and feed rate decreases. But visible damage and sieve over flow increases as the speed and feed rate increases (Table 5 and Figures 18, 19, 20 and 21).

Table 5: Performance of thresher on shelling maize

OSPU/SZ	OSYUW/PSTBSR/AEA	ISPUW/PSTBSR/AEA	QVUS/PUPF-S/AEA	OSaSAUW/AEA
I DADAD	€	FFB	QB	EB
I DCEACE	FE	FFB	D	DQ
I DCEACE	FEF	DQ	QB	DEF
I EADACE	€F	FFB	D	EB
I EACEACE	€	FFB	DB	DD
I EACEACE	FEF	FFB	QB	DEF

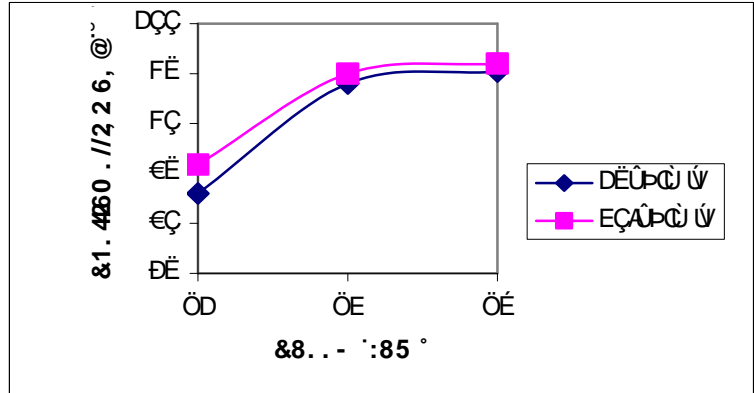

Figure 18: Effect of speed and feed rate on shelling efficiency of maize

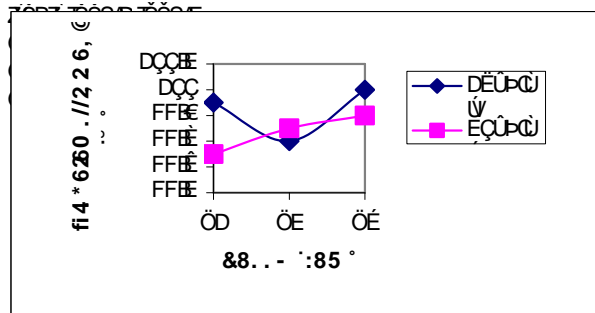

Figure 19: Effect of speed and feed rate on cleaning efficiency of maize

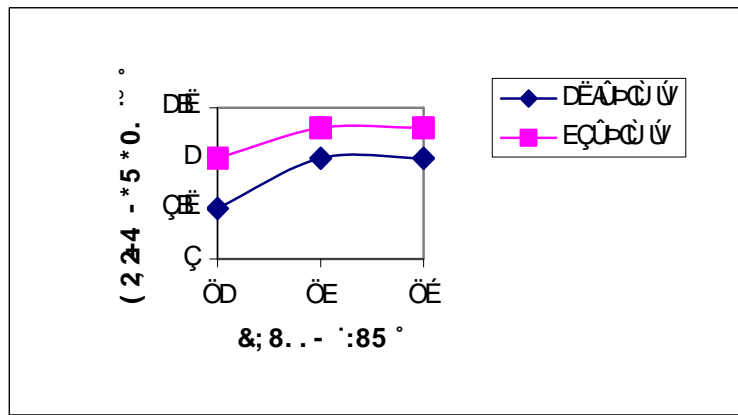

Figure 20: Effect of speed and feed rate on visible damage of maize

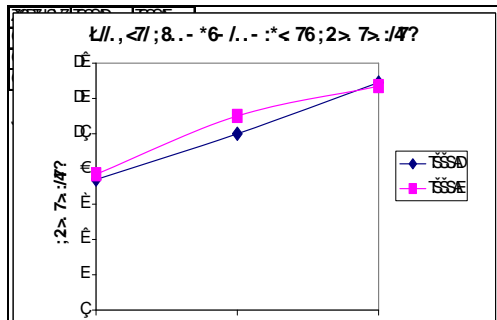

Figure 21: Effect of speed and feed rate on sieve overflow of maize

; ` \_ Tlf dZ \_

- The best combination for maximum threshing and cleaning efficiency with minimum visible grain damage and sieve loss are obtained as follows.
- During threshing of wheat the maximum output of 130kg/hr is obtained at a feed rate of 8kg/min and cylinder speed of 900rpm.
- During threshing of barely the maximum output of 120kg/hr is obtained at a feed rate of 8kg/min and cylinder speed of 900rpm.
- During threshing of the maximum output of 194kg/hr is obtained at a feed rate of 10kg/min and cylinder speed of 1000rpm.
- During threshing of sorghum the maximum output of 636kg/hr is obtained at a feed rate of 14kg/min and cylinder speed of 600rpm.
- During Shelling of maize the maximum output of 665kg/hr is obtained at a feed rate of 15kg/min and cylinder speed of 400rpm.

Therefore, the machine can save labour and operation time by 50% when compared with conventional method of threshing for the abovementioned crop types.

## I WwV TV

Bosoi. E.S, O.V. Verniaev, 1991. Theory, Construction and calculation of agricultural machineries volume II. A.A, Balkema/ Rotterdam

Firew Kelemu, Muluken Tadele, Awotahegn Tesefay, 1994. IAR research report. Melkasa, Nazareth. Ethiopia.

Nagpal G.R, 2003. Machine design. Khanna publishers.

Sahahy K.M, Singh K.K, 2003. Unit operations s of Agricultural processing. Vikas publishing house pvt ltd.

Testreport 1992. Combolcha agricultural mechanization research center, Combolcha.

# Performance Evaluation of Donkey Drawn Carts

Wolelaw Endalew

Bahir Dar Agricultural Mechanization Research Center  
P.O.Box 133, Bahir Dar

## **9 Sdecrle**

This paper describes the comparative study of transport capacities of donkey drawn carts. Three types of rigid wheel donkey drawn carts were used to undertake this study. The carts used for the study include: AIRIC model I, AIRIC model II (raised bed type) and the cart modified at Bahir Dar Agricultural Mechanization Research Center based on AIRIC model I. Load levels used for study are: empty cart condition, 100 kg, 200 kg, 300 kg, 400 kg, 500 kg and 600 kg. The test was conducted on dry, compacted and flat track of length 0.2 km at Bahir Dar. Two mechanical weight sensor transducer dial spring balances (Range 0.20-50.00kg and resolution 0.20 kg) were connected on two draw bar beams with a specially designed universal hitching arrangement. Measurements to collect the data regarding speed and average draft force were taken at each 20 meter interval and five runs were taken for each load level. The result shows that the maximum safe load for transport should not be greater than 300 kg for AIRIC model I cart. But the maximum load limit can be up to 400 kg using the AIRIC model II (raised bed type) and the cart modified at Bahir Dar Agricultural Mechanization Research Center. The test reveals that the modified cart has 12 % improvement of transport capacity over AIRIC model I cart and 6 % over AIRIC model II donkey cart.

## **A ec` Uf TeZ \_**

Transport-the carrying of things-is an important but difficult part of the domestic workload in rural Ethiopia. It is a year round task for both agricultural and non-agricultural purposes. Transport used to move crop harvest, take crop for marketing, deliver farm inputs & farm implements, and carry forage are some of the major activities related to agricultural purposes. Other tasks such as collection of fuel wood and water, transport of grains to and from grinding mills and transport of construction materials are often the biggest transport burdens related to non agricultural purposes, which require significant amount of both time and energy.

The mode of transport in most isolated rural areas of Ethiopia is traditional. It is characterized by low capital cost, low technology, low speed, low capacity, and low skill (Crossely P., 1991). Goods are mainly carried by both human portorage and using equines (mules, donkeys and horses) on footpaths and trails. Women are responsible to carry the biggest transport burden which is very arduous. As there is also a clear division of labor among equines, donkeys are widely used as pack animals in different agro-ecological zones. They are mostly used to carry loads of 20-50 kg within a distance of 20 km with a very low transport capacity of 0.25 ton km/hr (Crossely P., 1991). However, donkeys are used to draw carts in some areas of the country. The most notable area to mention is around Rift Valley located in the central part of the country. At first, donkey drawn carts used in these areas were constructed from wooden axle and steel hubs fitted with steel wheels. Field observation on these carts revealed that loose fittings of wooden

axle has resulted in side movements of the cart and high draft requirement, hence the load transported was not more than 200 kg (Kebede and Bekele, 1990).

Agricultural Implements Research and Improvement Center (AIRIC) at Melkassa has improved the transport capacity and durability of locally used wooden axle donkey drawn carts. Improvement attempt has mainly focused on the wheel axle assembly of the cart. Comparative transport performance study of the improved donkey drawn cart (AIRIC Model I) with the locally used wooden axle cart has revealed that there is 200% improvement over the wooden axle cart. The study report showed that draft requirement of AIRIC model I cart vary from 27.5 N at no load condition to 320.8 N at 600 kg payload on flat dirt track road conditions (Kebede and Bekele, 1990).

An attempt was made to introduce AIRIC model I cart in the main roadside areas of East Gojjam, which are suitable for carting. The road condition of these areas varies from gravel road to farm roads with ruts, holes and stones on it. However, despite the fact that this cart demonstrated a great potential for success in the flat fields of Rift Valley areas, some problems were observed on the use of it in the East Gojjam area.

One of the problems was that, when hitched with donkey the cart bed inclines back since the donkey height is greater than the cart height. Because of this, there is a frequent sliding of the load towards the back of the cart. In addition to this, it is difficult to transport fuel wood and other long beams since the height of the cart bed from the ground becomes very low at the back of the cart. The problem is magnified when the cart is operating at fields other than flat and suitable for carting. The second problem was that the large contact area of cast iron bushing with steel axle needs frequent as well as proper lubrication and exclusion of abrasive materials. Seizure was frequently occurred when the cast iron bushing runs on steel axle requiring high draft.

Cognizant of these problems, Bahir Dar Agricultural Mechanization Research Center has improved the wheel axle assembly of the cart and its bed position. Cart modification was started based on field observations on AIRIC Model I Donkey Drawn Cart. Working donkey body size measurement data around East Gojjam area, primarily generated for harness design was used to determine cart bed position and pull beam length. The donkey body measurement, which was conducted in 1998 and useful for modifying the cart include height, length and rib width (at three locations along the rib length), Meanwhile AIRIC also has made improvements on the cart more or less with similar attempts. Thus it becomes necessary to compare the performance of these carts and hence this study aimed to compare the performance of donkey drawn carts and select suitable ones.

#### **D ReVcZjdR UD V6Y Ud < VdlcZaeZ\_ ` W Rced**

The AIRIC Model I Donkey Drawn Cart has two pull beams, cart bed and the wheel axle assembly (Figure 1). The cart bed platform is made of eucalyptus plank, which is nailed to the pull beam. The pull beam is attached to the axle using bolts and U shaped plates.

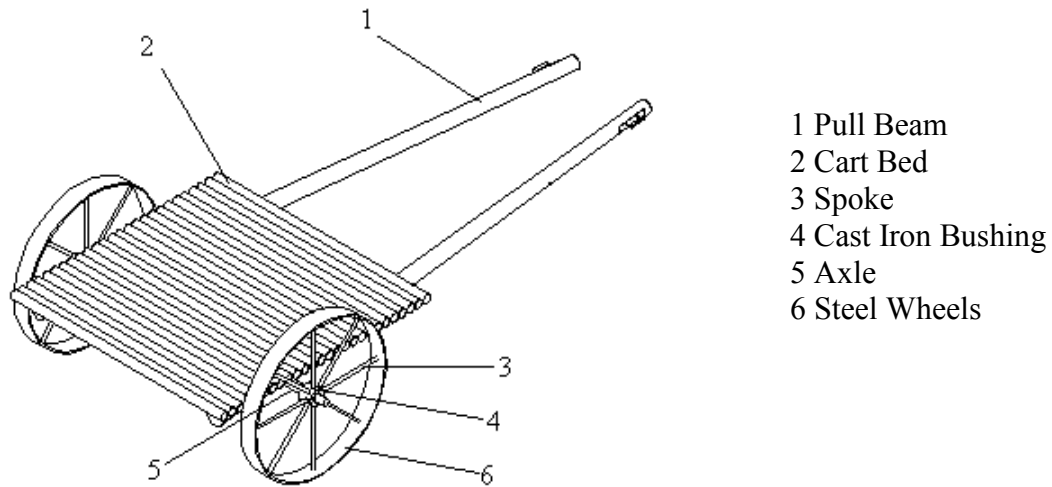

Figure 1: AIRIC Model I Donkey Drawn Cart

The wheel axle assembly consists of axle, bushing, spokes and steel wheel. Galvanized pipe welded with steel stubs are used as axle. Bolts are welded on each end of the cart axle so as to attach the plat form with U shaped plates. Cast iron bushings are used as bearings for the cart and attached to the wheel by steel spokes. Eight steel spokes are welded on the cast iron bushing as well as on the steel wheel.

#### **D` UZMU<`\_\ Vj <cRh\_ ; Rce**

The cart modified at Bahir Dar Agricultural Mechanization Research Center consists of raised cart bed, support frame, and the wheel axle assembly. The cart bed is a platform of wooden structure used to place the live load on it.

It is constructed from three eucalyptus planks of size 1200 mm x 60 mm x 30 mm as transverse battens, which are nailed to the pull beams with about 500 mm distance between each batten. Longitudinal planks of 1200 mm x 100 mm x 20 mm are nailed on the transverse timbers to make the platform (Figure 2). The pull beams are arranged at a center to center distance of 1070 mm and 350 mm at the back and front of the cart respectively. This distance allows adequate space to construct the bed platform as well as to hitch the cart with the working donkey.

The V shaped support frame is used to support the cart bed. It transfers the load coming from the cart bed to the wheel axle assembly and keeps the cart bed at suitable height from the ground. The support frame is constructed from 40 mm x 40 mm x 4 mm angle iron and mild steel sheet plates, which are welded on the top and bottom of it. The top plate is used to attach the cart bed and the bottom plate is used to bolt it with the wheel axle assembly.

The wheel axle assembly is the main component of the cart, which helps the cart to roll on the ground. It consists of the axle unit, the bearing housing and the spoked steel wheel. The axle is made from galvanized pipe of 2" in diameter fitted with stepped round steel stubs at each end. Mild steel plates are welded on the axle so as to fix the support frame bottom plate.

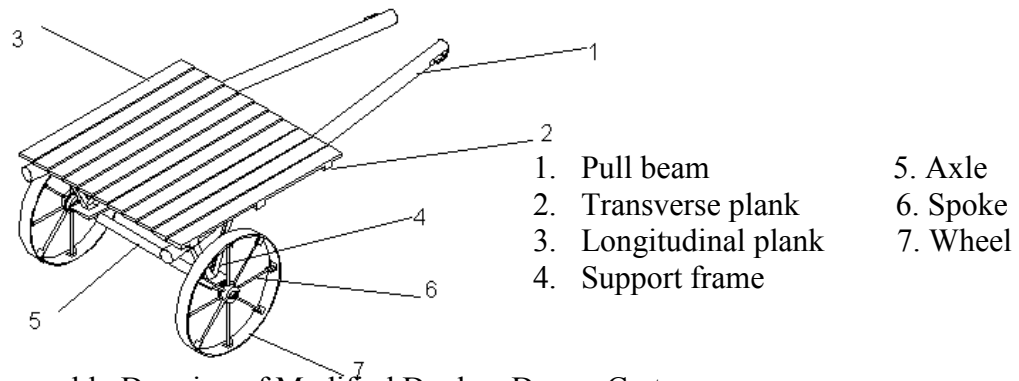

Figure 2: Assembly Drawing of Modified Donkey Drawn Cart

Vehicle rubber scrap is sandwiched between the axle plate and support bottom plate to minimize the strains coming from rigid wheel. The bearing housing is made from a specially turned and bored steel bar of 80 mm in diameter so as to accommodate double row ball bearings in each side. Eight spokes of diameter 14 mm and length 305mm are welded at each wheel where one end of the spoke is welded on the steel hub and the other end on the steel wheel. The steel wheel constructed from flat iron has a diameter of 700 mm which is sufficient to overcome ruts, holes and field obstacles.

**AIRIC Model II Donkey Drawn Cart**

The overall construction of the AIRIC Model II Donkey drawn cart is similar with the modified cart. The difference lies on the size of some cart components. It consists of raised cart bed, support frame, and the wheel axle assembly (Figure 3).

The cart bed is made of eucalyptus timber and nailed on the pull beams. It lies on the support frame and fixed with bolts and nuts. The V-shaped support frame is used to support the cart bed. It transfers the load coming from the cart bed to the wheel axle assembly and keeps the cart bed at suitable height from the ground. The support frame for this cart is also constructed from 40 mm x 40 mm x 4 mm angle iron and mild steel sheet plates, which are welded on the top and bottom of it. The top plate is used to attach the cart bed and the bottom plate is used to bolt it with the wheel axle assembly.

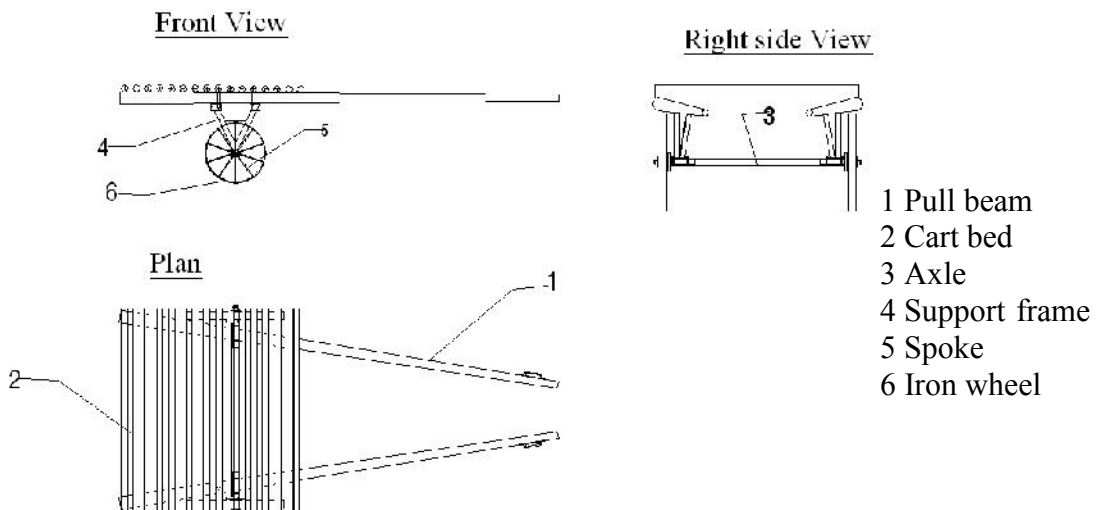

Figure 3: AIRIC Model II Donkey Drawn Cart  
**KVdeZ X**

Three types of donkey drawn carts were used for the test purpose. The carts used for test include: AIRIC’s donkey drawn cart (AIRIC Model I), AIRIC’s donkey drawn cart (ARIC model II) and modified donkey drawn cart at Bahir Dar Agricultural Mechanization Research Center. These carts were hitched with a male working donkey of weight 117 kg using saw back saddle harness developed at Bahir Dar Agricultural Mechanization Research Center. The harness was used with sufficient padding to minimize strain on the working donkey due to fluctuating load coming from the steel wheel.

The test was conducted on dry, compacted and flat track of length 0.2 km at Bahir Dar. Measurements to collect the data were taken at each 20 meter interval and five runs were taken for each load level. Load levels of empty cart condition (no load), 100 kg, 200 kg, 300 kg, 400 kg, 500 kg and 600 kg were used for the test purpose.

The average draft force used to draw the cart at various load levels was measured using two mechanical sensor transducers of dial spring scales (SALTER Model 235 6S, range 0.20 kg -50.00 kg and resolution 0.20 kg), which are connected on two draw beams. The universal hitching system was developed to attach the scales to the beams for recording the draft requirement (Figure 4).

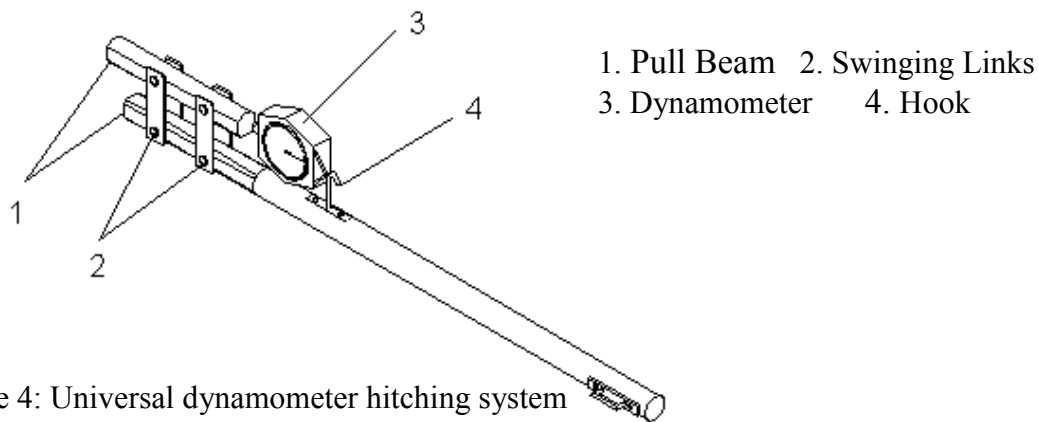

Figure 4: Universal dynamometer hitching system

**I Vdf ]e R\_U < ZIf ddZ \_**

Each donkey cart was subjected to load levels of empty cart condition, 100 kg, 200 kg, 300 kg, 400 kg, 500 kg and 600 kg. The corresponding draft and speed were recorded. The power required to draw the cart and transport capacities were calculated based on these conditions. The results of draft and speed as well as calculated values of power and transport capacity for three types of donkey drawn carts are summarized in Tables 1,2, and 3.

The data in Table 1 shows that draft requirements of AIRIC Model I donkey drawn cart. It varies from 33.42 N at empty cart condition to 291.1 N at a payload of 500 kg. Draft recorded for the cart exceeds the optimum recommended draft range at the load level of



400 kg as draft force requirements for donkey drawn equipment is recommended in the range for single donkey to be 130-230 N ( Betker and Kutzbach, 1991).

The results obtained for this cart vary with the results obtained at Melkassa on dirt track condition. This variation is thought to be due to difference in pull angle condition. Donkey height in Rift Valley areas is greater than donkey height around Bahir Dar area; hence increase in pull angle decreases draft.

Table 1: Draft Performance Results of AIRIC Model I Donkey Drawn Cart

C RUJgVd						
GRcR^ Vc	= ^ aej TRce	- , , \ X	., , \ X	/ , , \ X	0 , , \ X	1 , , \ X
< cRWSE%	// 0. \$ 34%	24 2\$ 7 2%	- . - \$ 3. %	- 35% 0% . %	. / 5 2\$ 45%	. 5 - * \$ 1 2%
Ja WU\$^ d%	- * 0\$ * %	- * \$ * %	, 45\$ * . %	, 44\$ * 1%	, 3\$ * %	, 15\$ * %
G h Vc \$M%	/ 4 * 5	24 * 2	- , 3 * 25	- 13 * 2	- 23 * 3.	- 3 - * 31
; Ra RIZj	)	, 7 2	, 20	, 51	- *	- * 2
\$e`_d \ ^ Hc%						

Note: The values in parentheses are standard deviations

As seen in Table 2, the draft requirement for AIRIC model II donkey drawn cart varies from 29.6 N at empty cart condition to 273.66 N at load level of 500 Kg.

Table 2: Draft Performance Results of AIRIC Model II Donkey Drawn Cart

C RUJgVd						
GRcR^ Vc	= ^ aej TRce	- , , \ X	., , \ X	/ , , \ X	0 , , \ X	1 , , \ X
< cRWSE%	. 5 2\$ * %	21 3/ \$ 2%	- - - * 1\$ 0 - %	- 21 7 \$ * . %	- . 5 0 * 2. %	. 3/ * 22\$ 4/ %
Ja WU\$^ d%	- * 4\$ * %	- * \$ * 0%	, 5. \$ 7 %	, 5\$ * 3%	, 30\$ * %	, 2 - \$ * %
G h Vc \$M%	/ 0 * 5.	3. 7	- , . 14	- 04 * 33	- 2. * 2	- 22 * 45
; Ra RIZj	)	, 7 5	, 22	, 53	- * 2	- * 5
\$e`_d \ ^ Hc%						

Note: The values in parentheses are standard deviations

From Table 3, the draft requirements of modified donkey cart ranges from 26.22 N at empty cart condition to 254.9 N at 500 kg payload. The draft requirement of all carts at load level of 600 kg exceeds 350 N, where the working donkey has made only a short walk and refused to pull the cart.

Table 3: Draft Performance Results of Modified Donkey Drawn Cart

C RUJgVd						
GRcR^ Vc	= ^ aej TRce	- , , \ X	., , \ X	/ , , \ X	0 , , \ X	1 , , \ X
< cRWSE%	. 2 * . \$ * 4%	2/ 3/ \$ 12%	- , 3 0\$ * 3%	- 0 - \$ 0%	- 55\$ 0 * 4%	. 10 * 5\$ * 3%
Ja WU\$^ d%	- * \$ * %	- * - \$ * %	, 54\$ * %	, 5. \$ * 0%	, 34\$ * . %	, 20\$ * , 2%
G h Vc \$M%	/ - 02	3, 3	- , 1 * 1	- . 5 * 3.	- 11 * .	- 2/ * /
; Ra RIZj	)	, 7 5	, 3	, 55	- * .	- * 1
\$e`_d \ ^ Hc%						

§`\_d\ ^ ^%e%

Note: The values in parentheses are standard deviations

The highest working speeds of 1.14 m/s, 1.18 m/s and 1.2 m/s were recorded at empty cart condition for AIRIC model I, AIRIC model II, and modified cart, respectively. At load level of 400 kg, the working speeds recorded were 0.7 m/s, 0.74 m/s and 0.78 m/s for the respective carts. An increase in payload increases the net draft which decreases the working speed. The maximum power out put was calculated as 167.72 W, 162.06 W and 155.22 W for AIRIC donkey model I donkey cart, AIRIC model II donkey cart and modified cart respectively at load level of 400 kg.

The transport capacities of carts at 400 kg load level were calculated as 1.0 tons km/hr, 1.06 tons km/hr and 1.12 tons km/hr for AIRIC model I, AIRIC model II, and Modified cart, respectively. There is a slight transport capacity variation between these three carts. The Modified cart had 12 % improvement of transport capacity over AIRIC model I cart and 6 % over AIRIC model II donkey cart. In spite of having ball bearings in their wheel axle assemblies for both Modified and AIRIC model II carts, there is a slight variation on their transport capacity. This variation is mainly due to the structural difference in track width, bed size, and pull beams length, which affects cart dead load.

Modified donkey cart weighs 90 kg and AIRIC Model II cart weighs 113 kg. Draft is a function of dead load, live load, wheel axle assembly, soil condition, and draft angle. This increase in dead load also increases the net draft, thereby reducing the transport capacity.

; ` \_Tjf dZ \_dR UI VT ^ ^ V\_URz \_d

Modified donkey cart and AIRIC model II donkey cart have showed better performance and hence could be used on flat areas of the region on gravel and farm roads. These carts can be manufactured by small workshop owners with exception to the steel hub, which requires lath. The total cost for manufacturing these carts is estimated as 7000 ET. Birr. The following points should be considered while using these donkey drawn carts.

- Pay loads should not exceed 400 kg as the draft requirement is recorded beyond the capacity of average working donkey.
- Sufficient padding should be used with suitable harness so as to minimize strain to working donkeys due to fluctuating loads.
- Loads should be uniformly placed on the cart platform and tied with rope to ensure cart stability.
- Use of smooth or padded straps is recommendable as there is excessive strain to animals

The rigid steel wheel transmits fluctuating loads to working donkey as well as cart components. The strain affects the work output of donkey and cart spokes are likely susceptible to the strain as a result the steel wheel may collapse. These loads can be minimized by introducing some cushioning materials to the wheel, suspension or hitching assembly of the cart. Future work has to focus on developing rubberized steel wheels (RSW) with suitable rims and suspension as well as hitching components. Selection of durable, low cost and weight cart materials with suitable cart component size need great attention.

## I WwV\_TM

- Adarsha M.S., Harsha H.D. and Kurup T.N.K. (2003). Rubberized steel wheels-an innovative design for better use of animal energy in India. 39, 28-32. Center for Tropical Veterinary Medicine, University of Edinburgh.
- Betker J. and Kutzbach H.D. (1991). The role of Donkeys in agricultural mechanization in Niger-potential and limitations. In (eds D.Fielding and R.A.Pearson). Edinburgh: Alexander Ritchie & Son Ltd. pp. 223-230.
- Colin Relf. (1998). Obvious, but not easy. Promoting non-motorized means of transport. g 3, 20-30. Eschborn, Fedral Republic of Germany.
- Crossely P. (1991). Transport for rural development in Ethiopia. In (eds D.Fielding and R.A.Pearson). Edinburgh: Alexander Ritchie & Son Ltd. pp. 48-61.
- Kebede A. and Bekele D. (1990). Improvement of transport capacity of donkey carts. 12, 17-20. Center for Tropical Veterinary Medicine, University of Edinburgh.
- Smith D.W., Sims B.G. and O'Neill D.H. (1994). Testing and evaluation of agricultural machinery and equipment. Food and Agricultural Organization of the United Nations. Agricultural Service Bulletin 110. Rome.

### Acknowledgements:

I would like to acknowledge Ato Zewdu Ayalew from Bahir Dar Agricultural Mechanization Research Center for his suggestions both on the content and structure of this paper.

**KWZ\_XF f e) < ` ` c Je` cRXV Jecf Tef cVd` \_ D RZV**  
Abu Teffera, Wolelaw Endalew and Negese Yayu  
Bahir Dar Agricultural Mechanization Research Center  
P.O.Box 133, Bahir Dar

## 9 SdecRle

An experiment was conducted to compare the quality of maize stored in three different types of storage structures (locally made in-door storage Gotta, out-door raised bed and mud silo storages) of approximately similar dimension.

Important parameters like surrounding temperature, relative humidity, moisture content, thousands grain weight, grain temperature and total observation data were collected and recorded through out the storage period. Based on the collected data the condition of stored maize was evaluated.

It was found that, in all storages minimum fluctuation of moisture content (minimum on the month of April 8.4% in raised bed and maximum on the month of September 11.1% in mud silo storage) and grain temperature difference were recorded. In all Gottas and mud silo storages

after four months, it was seen more maize grain breakage due to rats and crawling of pests also was began to be seen.

Seed count and thousand grain weight data measurement show that the mean difference is significant at the 0.05 level among storages. Maize stored in raised bed storage structure was found to be better in terms of grain loss in comparison with those at mud silo and Gotta. Average percentages of grain loss during eight months of storing period were 4.17, 6.15 and 7.66 % for raised bed storage, mud silo and gotta, respectively.

### Agriculture

The purpose of all grain storage structures is to furnish protection against deterioration due to rain and soil moisture, provide a barrier against insects and vertebrate predators, maintain stable temperatures inside the storage, reduce the grain surface exposed to ambient air, and reduce the uptake of moisture by the grain after rain or during the night (Boxall R.A.). Grain storage is carried out by different social groups to satisfy their interest at various levels for a number of purposes, i.e for market, and food for the household and future use.

Between 60% and 70% of grain production in Africa is stored at farm level, generally for family consumption but also for sale and for seed. Storage methods which have evolved over many generations are often well adapted to local conditions (Agboola, 1994).

In Amhara region the main cereal grains cultivated are wheat, maize, sorghum, barley, wheat and finger millet. Recent investigations have shown that due to use of improper facilities and storage techniques, serious quantitative and qualitative losses occur on some of these crops. A study undertaken by FAO has estimated the post harvest quantitative loss in grain to be around 25% of annual production. One of the methods for minimizing these post-harvest losses is introducing of improved storage structures. This method would not only lead to a substantial increase in the income of the farmer but also gross national product of these essential commodities.

The need for storage of grain in the region occurs mainly because of the seasonal nature of production. Grains have to be stored for periods ranging from 3-8 months. At harvest, farmers sell 50 to 60% of their produce, which is referred to as the marketable surplus, and they keep the rest for their own consumption, for seed purpose and for future sale. (Yonas metafiria and melaku Jirata, 2003)

Farmers use a variety of traditional storage structures to keep their harvested grain. Based on their locations they are categorized as indoor, out door and underground storages. Among these varieties of storages most farmers used to keep their harvested grain by traditional indoors storage structures like clay pots, woven basket, small mud-straw bins (Gotta), sacks and different containers. However, this traditional storage structure invites insects and rodents into the house and also complicates the household hygiene. In addition, structures and containers reduce the room available in residential houses. Even though, traditional storage structures are not expensive and are easy to manufacture by farmers themselves, it lacks to create suitable environment to store grain and to prevent grain damage by loss causing agents.

That is why in the past years there have been several attempts to introduce improved out door storage structures to various farming communities in the Region by governmental and non governmental organizations. However, most of the efforts were directed towards introducing of storages that lack the necessary technical information

Therefore, the objective of this study was to present experimental studies on the performance of different types of storages structures and based on the results to select and recommend the best ones to the farming community

### **Discussion**

For site selection, specific criteria were developed, i.e, maize production potential, occurrence of storage pests, and awareness about the improved storage structures among farmers, availability of local construction materials, road accessibility, and closeness for monitoring purpose. Site selection was made through discussion with relevant institutions such as wereda council, development agents at site, farmers service co-operatives, and so on. Based on the criteria's and discussions made, the trial site for testing of storage structures for maize had been selected at Alafa in west Gojjam zone

The location of each raised bed and mud silo out-door storage structures were selected randomly using lottery system, the first pick on the first number was erected (Figure 1). The structures of out door storage structures are presented on Figures 2 and 3. Gotta as in-door storage structure was placed inside farmers' house near the kitchen which is not far from main storage trial site (Figure 4).

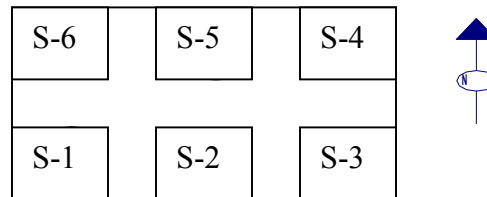

S.1 – Raised bed S.2 – Mud silo S.3 - Mud silo S.4 - Raised bed S.5 - Raised bed S.6 - Mud silo

Figure 1: Construction lay-out for out door storage structures



Figure 2: Mud silo



Figure 3: Raised bed storage



Figure 4: Traditional in door storage storage

Two different types of cylindrical out door storage statures, i.e. raised bed and mud silo storages made of wood, grass and straw were constructed according to the lay out on the area of 100 square meters. (Figure 1) The construction materials and dimensions of the two storage structures more or less were identical. The difference is being rested on the ground with concrete floor for mud silo and suspended above the ground with four posts for raised bed storage structure (Figures 2&3)

The traditional one which is constricted out side the trail site, because of its functional condition, was also build using animal dung, chopped straw and clay soil not far from the trail site area by experienced local farmer. This storage has the same shape and holding capacity as that of the out door storages.

After the arrangement of storages on their respective location, all of them were filled with 400kg of maize variety BH660 which was harvested from the same area. To eliminate field pests, all stored maize was fumigated.

To monitor the surrounding temperature and relative humidity, thermo-hydrograph was installed inside experimental site and data was recorded through out the storage period. Grain temperature at the depth of 20cm was taken by digital thermometer at five locations in each of the storage structures as shown in Figure 5. The moistures content of the grain where also determined using quick grain moisture tester. Every month data was recorded through out the test period. (May 2001 to December 2002)

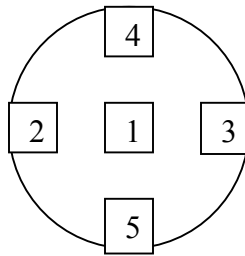

Figure 5: Horizontal section of an Experimental cylindrical storage bin with the position of data taken for grain sample and temperatures (1-center, 2-East, 3-West, 4-south, and 5-North).

Two-grain samplers and sample holding boxes were manufactured at Bahir Dar Agricultural Mechanization research center and were used to collect and hold grain. Grain samples were collected from nine equal intervals and at five position of each storage bin (Figure 5) in an interval of 30 days. A representative samples was obtained from the depth penetrated by the sampler. Using count and weight methods samples were analyzed for the moisture content and weight losses (damage) of grain, respectively. This method provides an estimate of loss where a base line cannot be obtained at the beginning of the storage season (Anon, 1996). Three samples, each of about five hundred grains, were extracted and the grains in each sample were then sorted into the damaged and undamaged grain and then counting and weighting each fraction. (Peace Crop, 978.) The data then was substituted into the following equation and calculated for percentage of weight losses.

$$(U \times Nd) - (D \times Nu) / U(Nd + Nu) \times 100 = \% \text{ weight loss}$$

Where U = weight of undamaged grain  
 D = weight of damaged grain  
 Nu = Number of undamaged grain  
 Nd = Number of damaged grain

Each treatment and measurement was replicated three times and completely randomized design was used. Statistical analysis was performed using SPSS package.

**I Vř ]ed R\_ U < ŽIF dZ\_ d**

The temperature and moisture content of the stored maize varied with time because of changes in weather condition. Ambient temperature and relative humidity for the storage period starting from April 1/2001 to December 30/2002 is shown in Figure 5 the relative humidity and ambient temperature were fluctuated between 40 to 50% and 20 to 28 °C respectively for about seven months and finally ambient temperature dropped down.

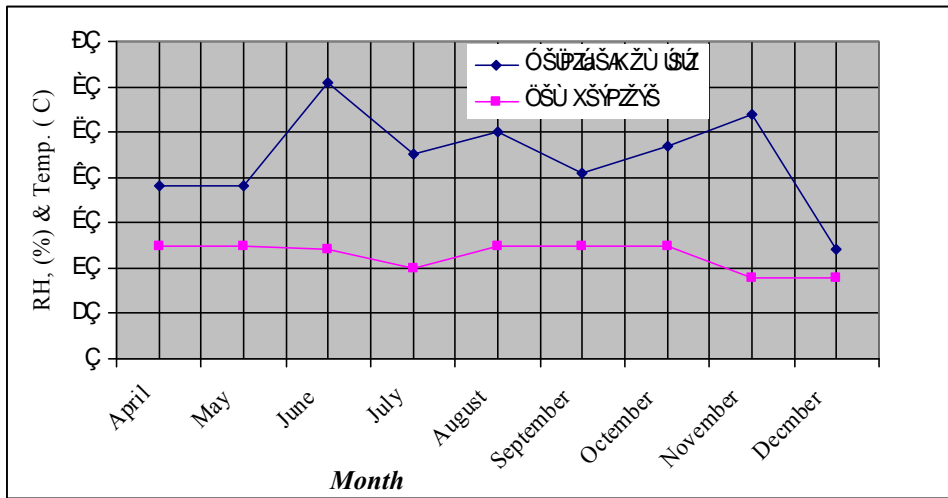

Figure 5: Ambient temperature and relative humidity changes during storage time of maize

The grain temperature changes for stored maize in different types of storage structures are shown in Figure 6 The temperature in all storage structures decreased gradually at the beginning of storage from the month of April to June and then increased gradually up to the month of October.

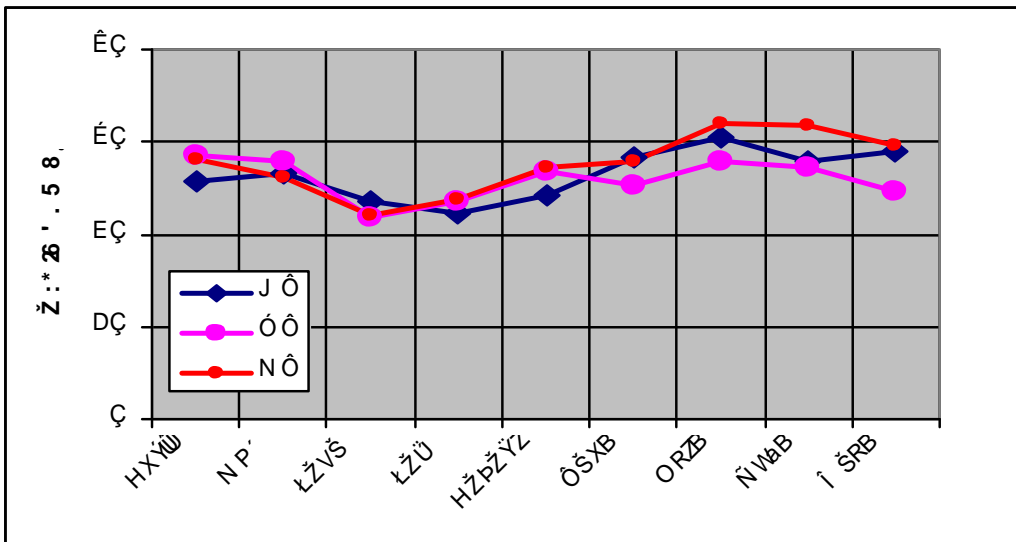

Figure 6:

Studies indicate that temperature between 21 °C– 43 °C speeds up the life processes of all organisms (Yonas Metaferia and Melaku Jirata 2003). Therefore, the ambient grain temperature were within the optimum range for insect infestation. However, for the first four months, the rate of infestation was very low and also significant number of insects was not observed in all storages. After the month of August, the grain temperature started to increase because of an increase in ambient temperature and respiration of grain. The highest grain temperature was 31.8 °C in the mud silo storage (Figure 9).

Statistical analysis of grain weight losses using count & weight method of sampling in different storages by multiple comparisons (ANOVA) show that, the mean difference was significant at the 0.05 level between raised bed and Gotta, whereas, there was not significant difference among mud silo storages (Table 1 and 2)

In the case of thousand grain mass sampling method, the statistical analysis indicate that the raised bed storage mean difference was significant at the 0.05 level from both storages (Table 2).

Average percentages of grain loss during eight month storing period w

		N ŠPV Ī ŪŠŸSVRŠ ĀĀĀ		ŌZSEĀ YŸW	ŌŪE	FĒĀĒ Ī WŪŠŠVRŠAVZŠĀPŪ	
ĀĀĀ ŸPŪĀŌZŸNPŠŸĀĀĀ ŸPŪĀŌZŸNPŠ						MĀŠŸĀ VZVS	OXXŠŸĀ VZVS
MŌĪ	J Ō	N Ō	B̄DĒE	D̄B̄D̄D̄Ç	B̄ĒĒĒ	Ā̄B̄F̄ĒEÇ	Ē̄B̄D̄ĒD̄
		Ō Ō	ĒB̄F̄ĒEÇ	D̄B̄D̄D̄Ç	B̄ÇĒĒ	F̄B̄ĒĒĒ ĀÇ	Ē̄B̄ĒĒĒĒ
	N Ō	J Ō	Ā̄B̄D̄ĒĒ		B̄ĒĒĒ	Ā̄ĒB̄D̄ĒD̄	D̄B̄F̄ĒEÇ
		Ō Ō	ĒB̄ĒĒĒ	D̄B̄D̄D̄Ç	B̄D̄ĒD̄	Ā̄B̄ĒD̄ĒD̄	Ē̄B̄F̄D̄EÇ
	Ō Ō	J Ō	Ā̄B̄F̄ĒEÇ	D̄B̄D̄D̄Ç	B̄ÇĒĒ	Ā̄ĒB̄ĒĒĒ	Ā̄F̄ĒĒĒĒ ĀÇ
		N Ō	Ā̄B̄ĒĒĒ	D̄B̄D̄D̄Ç	B̄D̄ĒD̄	Ā̄B̄F̄D̄EÇ	B̄ĒD̄ĒD̄

Ā Ō Ū ŠĀ Ÿ P V Š Ū Š Ÿ S V R Š Ā Ÿ Ā Ū Ū Ū P V Z P Z Ā Ū Š Ā Ē Š Ā Š Ū



**KRS]V. 6J** statistical analysis of grain weight losses using thousand grain mass methods in different storage by multiple comparisons

Temperature and moisture are the major factors determining factors in accelerating or delaying of the complex phenomena of the biochemical transformation (especially the "breathing" of the grain). Furthermore, they have a direct influence on the speed and

development of insects and microorganisms.

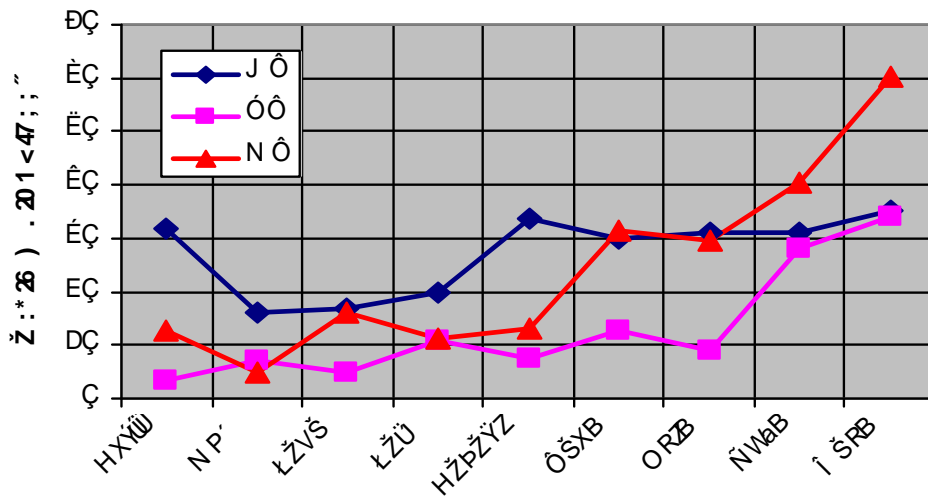

Figure 36 Percentage of grain weight losses during storage of maize in different storages (TGM)

Month

It was observed that after two months, the grain moisture content increased from 9.2%, 10.7% and 10.9%, in the Gotta, RS and MS storages, respectively. At the end of six months, the grain moisture content has dropped to 9.2 %, 9.3% and 9.5% (Figure 8). Since the safe moisture content of maize for storing is up to 13.5%, this variation of moisture content did not affect the maize condition (Yonas Metaferia and Melaku Jirata, 2003)

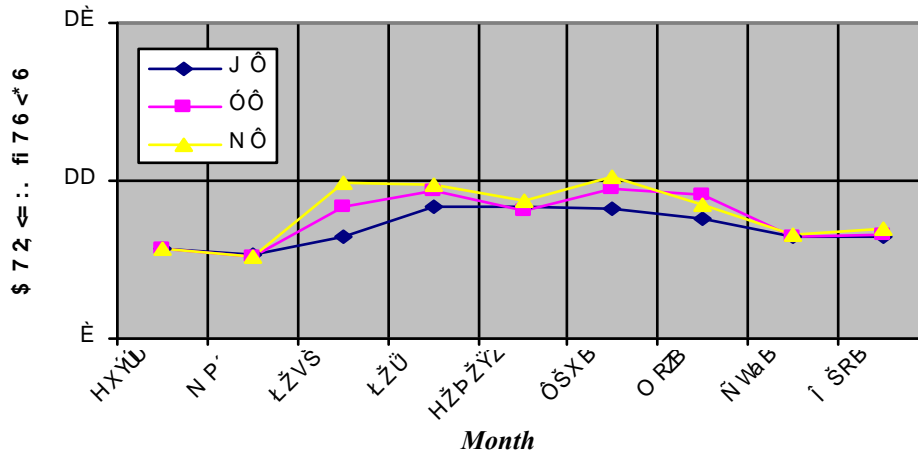

Figure 8: moisture content changes during storage of maize in three types of storage structures

Insects can live and reproduce at temperatures between +15°C and +35°C. But temperature depends not only on climatic conditions but also on the biochemical changes that are produced inside a grain mass, provoking undesirable natural heating of the stored products (Yonas Metaferia and Melaku Jirata, 2003). For that reason, climatic conditions did not favor significantly the emergency of common pests during the first three months of storage (May to July).

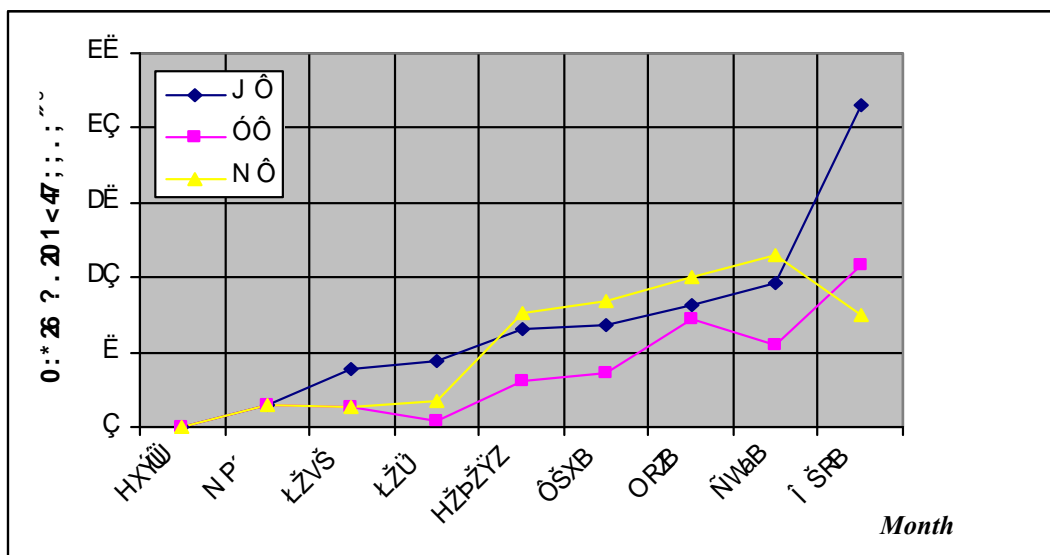

Figure 9: Grain weight losses during storage of maize in three types of storage structures (C&W)

Even though, high temperature (21<sup>0</sup>C- 43<sup>0</sup>C) speeds up the life processes of all organisms, (Melaku Jirata, May2003) during this time the percentage of grain loss was very low (Figure 9). But starting from August, grain losses increased, because of the accumulated insects feed on the stored maize and their metabolic processes produced heat and carbon dioxide. The added heat made the grain temperature to rise and accelerated development of large amount of insects (Figure 8 and 9). Up to the 3<sup>rd</sup> month in all types the storages existence of rice weevil, red flour Beetle and grain moth pests had been seen very few, but during the last three months of storage (October-December), the amount of observed crawling pests was extremely very high in GS and MS than RS. From observation, the wastage caused by the rice moth is negligible since it was limited to the upper stored grain. In the other hand, after the 3<sup>rd</sup> month of storage in all traditional storages ( ) and mud silo, the presence of mice was almost permanent. They enter in to and mud silo through the roof and/or by making holes at the base and causes serious damage and wastage of the stored produce both by their consumption and faecal contamination. This condition increased damage of grain in both indicated storages, where as for raised bed, because of its rat preventing mechanism attached on all its four legs, it was not a problem.

; ` \_Tjf dZ \_ R UI VT ^ ^ V URz \_

Even though all tested storages are capable of storing grain, the raised bed out door storage structure was found to be the best. Using of this storage structure in warm or cold area is suitable with its additional advantage of rat preventing mechanism and raised platform condition that reduces condensation and increases ventilation action. The result of the study also indicated that long period storing of maize with out inspection may

cause serious losses of grain. Therefore, the selected storage will be more effective if it is assisted by proper storage technique and managements which enhance the quality of stored produce. Some of them are:

- Activities in preparation for storage (cleaning the storage, destruction of infected residues, and selection of healthy ears at harvest) permit a substantial reduction of insect attack. Moreover, to ensure effective control, the use of chemical products can not be overemphasized.
- Inspection methods permit the detection of levels of infestation corresponding to application of a treatment in order to avoid serious grain losses and wasteful superfluous insecticide treatments. But to prevent insect infestation and damage the treatment should be applied to the grain immediately after harvest and at intervals of three to six months depending on the recommendation and type of the chemical.

## **I W&V TM**

Agboola, 1994. Technologies for the Storage of Food Crops in Nigeria FAO Workshop on African Experiences on Post-Harvest Technology Improvement, 4-8 July, Accra, Ghana.

Boxall R.A. Briece J.R. and Baneroft R.D. Technology and Management of Storage. (Chapter 5 pp 141-172)

Melaku Jirata, May 2003. Storage Pest Management, Hand out compiled for training of trainers on post harvest technology extension. Held from November 27-December 16, 2000 Addis Ababa

Peace Corp. 1978. programming and Training for Small Farm Grain storage 109p.

Yonas Metaferia and Mlaku Jirata, may 2003. Post Harvest Technology Management of Grain Crop. Hand out compiled for training of trainers on post harvest technology extension. Held from November 27-December 16, 2000 Addis Ababa